

**SSA3000X**

**Spectrum Analyzer**

User Manual

UM0703X-E03B

# Copyright and Declaration

## Copyright

SIGLENT TECHNOLOGIES CO., LTD All Rights Reserved.

## Trademark Information

**SIGLENT** is the registered trademark of **SIGLENT TECHNOLOGIES CO., LTD**

## Declaration

- ◆ **SIGLENT** products are protected by patent law worldwide
- ◆ **SIGLENT** reserves the right to modify or change parts of or all the specifications or pricing policies at company's sole decision.
- ◆ Information in this publication replaces all previously corresponding material.
- ◆ Any way of copying, extracting or translating the contents of this manual is not allowed without the permission of **SIGLENT**.
- ◆ **SIGLENT** will not be responsible for losses caused by either incidental or consequential in connection with the furnishing, use or performance of this manual as well as any information contained.

## Product Certification

**SIGLENT** guarantees this product conforms to the national and industrial standards in China as well as the ISO9001: 2008 standard and the ISO14001: 2004 standard. Other international standard conformance certification is in progress.

---

# Safety Information

## General Safety Summary

Carefully read the following safety precautions to avoid any personal injury or damage to the instrument and any products connected to it. To avoid potential hazards, please use the instrument as specified.

### Use Proper AC Power Line

Only the power cord designed for the instrument and authorized by local country should be used.

### Ground the Instrument

The instrument is grounded through the protective earth conductor of the power line. To avoid electric shock, please make sure the instrument is grounded correctly before connecting its input or output terminals.

### Connect the Probe Correctly.

If a probe is used, do not connect the ground lead to high voltage since it has isobaric electric potential as the ground.

### Look Over All Terminals' Ratings

To avoid fire or electric shock, please look over all ratings and sign instruction of the instrument. Before connecting the instrument, please read the manual carefully to gain more information about the ratings.

### Use Proper Overvoltage Protection

Make sure that no overvoltage (such as that caused by a thunderstorm) can reach the product, or else the operator might be exposed to danger of electrical shock.

### Electrostatic Prevention

Operate the instrument in an electrostatic discharge protective area environment to avoid damages induced by static discharge. Always ground both the internal and external conductors of the cable to release static before connecting.

### Maintain Proper Ventilation

Inadequate ventilation may cause increasing of the instrument's temperature, which will eventually damage the instrument. So keep well ventilated and inspect the intake and fan regularly.

### Avoid Exposed Circuit or Components

Do not touch exposed contacts or components when the power is on.

**Do Not Operate Without Covers**

Do not operate the instrument with covers or panels removed.

**Use proper Fuse.**

Use only the specified fuse.

**Keep Product Surfaces Clean and Dry.**

To avoid the influence of dust and/or moisture in the air, please keep the surface of the device clean and dry.

**Do Not Operate in Wet Conditions.**

In order to avoid short circuiting to the interior of the device or electric shock, please do not operate the instrument in a humid environment.

**Do Not Operate in an Explosive Atmosphere.**

In order to avoid damage to the device or personal injury, it is important to operate the device away from an explosive atmosphere.

## Safety Terms and Symbols

**Terms in this Manual.** These terms may appear in this manual:



---

**WARNING**

Warning statements indicate the conditions or practices that could result in injury or loss of life.

---



---

**CAUTION**

Caution statements indicate the conditions or practices that could result in damage to this product or other property.

---

**Terms on the product.** These terms may appear on the product:

**DANGER** Indicates direct injuries or hazards that may happen.

**WARNING** Indicates potential injuries or hazards that may happen.

**CAUTION** Indicates potential damages to the instrument or other property that may happen.

**Symbols on the product.** These symbols may appear on the product:



**Hazardous  
Voltage**



**protective Earth  
Terminal**



**Warning**



**Test  
Ground**



**Power Switch**

If find such symbols on the product, consult the manual to find out the nature of the potential hazard and the actions which have to be taken

## Measurement Category

### Measurement Categories

This analyzer can make measurements in other circuits that are not directly connected to mains.



#### **WARNING**

This analyzer can only be used for measurements within its specified measurement categories.

Not to use the product for measurements within other measurement categories, such as CAT II, CAT III, CAT IV.

Not to use the equipment for measurements on mains circuits

### Measurement Category Definitions

Measurement category II is for measurements performed on circuits directly connected to the low voltage installation. Examples are measurements on household appliances, portable tools and similar equipment.

Measurement category III is for measurements performed in the building installation. Examples are measurements on distribution boards, circuit-breakers, wiring, including cables, bus-bars, junction boxes, switches, socket-outlets in the fixed installation, and equipment for industrial use and some other equipment, for example. Stationary motors with permanent connection to the fixed installation.

Measurement category IV is for measurements performed at the source of the low-voltage installation. Examples are electricity meters and measurements on primary over current protection devices and ripple control units.

## Working Environment

### Temperature

Operating: 0°C to +50°C

Non-operation: -20°C to +70°C

### Humidity

Under +35°C: ≤90% relative humidity

+35°C to +40°C: ≤60% relative humidity



#### **WARNING**

To avoid short circuit inside the instrument or electric shock, please do not operate in humid environment.

---

### Altitude

Operating: less than 3 km

Non-operation: less than 15 km

### Degree of protection

IP20

### Installation (overvoltage) Category

This product is powered by mains conforming to installation (overvoltage) category II.



#### **WARNING**

Make sure that no overvoltage (such as that caused by thunderbolt) can reach the product, or else the operator might expose to danger of electric shock.

---

### Installation (overvoltage) Category Definitions

Installation (overvoltage) category I refers to signal level which is applicable to equipment measurement terminals connected to the source circuit. In these terminals, precautions are done to limit the transient voltage to the corresponding low level.

Installation (overvoltage) category II refers to the local power distribution level which is applicable to equipment connected to the AC line (AC power).

## Ventilation Requirement

This analyzer uses fan to force cooling. Please make sure that the air intake and exhaust areas are free from obstructions and have free air. When using the analyzer in a bench-top or rack setting, provide at least 10 cm clearance beside, above and behind the instrument for adequate ventilation.

**WARNING**

Inadequate ventilation may cause temperature increase which would damage the instrument. So please keep the instrument well ventilated during operation and inspect the intake and fan regularly.

---

## General Care and Cleaning

### Care

Do not store or leave the instrument in direct sunshine for long periods of time.

**WARNING**

To avoid damages to the instrument or probe, please do not leave them in fog, liquid, or solvent.

---

### Cleaning

Please perform the following steps to clean the instrument and probe regularly according to its operating conditions.

1. Disconnect the instrument from all power sources, and then clean it with a soft wet cloth.
2. Clean the loose dust on the outside of the instrument and probe with a soft cloth. When cleaning the LCD, take care to avoid scarifying it.

**WARNING**

To avoid damages to the surface of the instrument and probe, please do not use any corrosive liquid or chemical cleanser.

---

**WARNING**

Make sure that the instrument is completely dry before restarting it to avoid short circuits or personal injuries.

---

# L'information de sûreté

## Résumé général de sûreté

Lisez soigneusement les mesures de sécurité suivantes pour éviter n'importe quelles blessures ou les dommages à l'instrument et à tous les produits se sont reliés à eux. Pour éviter des risques, utilisez svp l'instrument comme indiqué.

### Employez la ligne à haute tension appropriée

Seulement le cordon de secteur conçu pour l'instrument et autorisé par le pays local a pu être employé.

### A rectifié l'instrument.

L'instrument est fondu par le conducteur protecteur de terra de la ligne à haute tension. Pour éviter la décharge électrique, le conducteur moulu doit être relié à la terre. Assurez-vous que l'instrument est fondu correctement avant de relier ses bornes d'entrée ou de rendement.

### Reliez le fil de signal correctement.

Le potentiel de l'au sol de fil de signal est égal à la terre, ainsi ne relie pas le fil de signal à une tension.

### Regardez estimations au-dessus de toutes les bornes des'

Pour éviter le feu ou la décharge électrique, regardez svp au-dessus de toutes les estimations et instruction de signe de l'instrument. Avant de relier l'instrument, lisez svp le manuel soigneusement pour obtenir plus d'informations sur les estimations.

### Employez la protection appropriée de surtension

Assurez-vous qu'aucune surtension (comme cela provoqué par un orage) ne peut atteindre le produit, ou bien l'opérateur pourrait exposer au danger du choc électrique.

### Empêchement électrostatique

Fonctionnez dans un environnement protecteur de secteur de décharge électrostatique pour éviter des dommages induits par décharge statique. A toujours rectifié les conducteurs internes et externes du câble pour libérer la charge statique avant de se relier.

### La ventilation insatisfaisante de ventilation

bonne de subsistance peut causer l'augmentation de la température, qui endommagera par la suite l'instrument. Gardez ainsi la ventilation bonne et inspectez la prise et éventez régulièrement.

### Évitez le circuit ou les composants exposés

ne touchent pas les contacts ou les composants exposés quand le courant passe.



---

**Employez l'utilisation appropriée**

de fusible seulement le fusible indiqué.

**Ne fonctionnez pas sans couvertures**

n'actionnent pas l'instrument des couvertures ou des panneaux étant coupés.

**Ne fonctionnez pas avec des échecs suspectés.**

Si vous suspectez les dommages se produisent à l'instrument, l'ont inspecté par le personnel de service qualifié avant d'autres opérations. N'importe quel entretien, ajustement ou remplacement particulièrement aux circuits ou aux accessoires doivent être exécutés par le personnel autorisé par **SIGLENT**.

**Ne fonctionnez pas en conditions humides.**

Afin d'éviter de court-circuiter à l'intérieur du dispositif ou de la décharge électrique, svp ne fonctionnez pas dans un environnement humide.

**Do Not Operate in an Explosive Atmosphere.**

Ne fonctionnez pas dans une atmosphère explosive.

Afin d'éviter d'endommager le dispositif ou les blessures, il est important d'utiliser le dispositif loin à partir d'une atmosphère explosive.

**Maintenez les surfaces de produit propres et sèches.**

Pour éviter l'influence de la poussière et/ou de l'humidité en air, maintenez svp la surface du dispositif propre et sèche.

**En manipulant la sûreté**

manipulez svp avec soin pendant le transport pour éviter d'endommager des boutons, des interfaces de bouton et d'autres parties sur les panneaux.

Le corps ou l'opérateur responsable devrait se référer au manuel d'instruction pour préserver la protection se permettent par l'équipement. Si l'équipement est utilisé en quelque sorte non indiqué par le fabricant, la protection fournie par l'équipement peut être altérée.

On ne permet à aucune pièce du dispositif et de ses accessoires d'être changé ou remplacé, autre qu'autorisé par le fabricant ou son agent.

Pas placez l'équipement de sorte qu'il soit difficile d'utiliser le dispositif débranchant (prise détachable).

## Limites et symboles de sûreté

**Limites en ce manuel.** Ces limites peuvent apparaître en ce manuel :



### Les rapports

d'avertissement D'AVERTISSEMENT indiquent les conditions ou les pratiques qui pourraient avoir comme conséquence les dommages ou la perte de la vie.



### Les rapports

d'attention d'ATTENTION indiquent les conditions ou les pratiques qui pourraient avoir comme conséquence les dommages à ce produit ou à toute autre propriété.

**Limites sur le produit.** Ces limites peuvent apparaître sur le produit :

Le DANGER indique les dommages ou les risques directs qui peuvent se produire.  
Dommages ou risques potentiels de WARNING indiqués qui peuvent se produire.

L'ATTENTION indique des dommages potentiels à l'instrument ou à toute autre propriété qui peuvent se produire.

Si la trouvaille de tels symboles sur le produit, consultez le manuel pour découvrir la nature du risque et des actions qui doivent être pris.

**Symboles sur le produit.** Ces symboles peuvent apparaître sur le produit :



Dangereux  
Tension



Protecteur  
Au sol de la terre



Avertissement



Châssis  
Ground



Puissance  
Switch

## Catégorie de mesure

Les analyseurs peuvent faire des mesures dans d'autres circuits qui ne sont pas directement reliés aux forces. Pour ne pas employer le produit pour des mesures dans d'autres catégories de mesure, telles que le CAT II, CAT III, CAT IV.

Ne pas utiliser l'équipement pour des mesures sur des forces circuitée, pour ne pas utiliser l'équipement pour des mesures sur la tension excèdent la gamme de tension décrivent dans le manuel.



---

### Les rapports

cet analyseur peut seulement être employé pour des mesures dans ses catégories indiquées de mesure.

---

### La catégorie II de mesure

de définitions de catégorie de mesure est pour des mesures effectuées sur des circuits directement reliés à l'installation de basse tension. Les exemples sont des mesures sur des appareils électroménagers, des outils portatifs et l'équipement semblable.

La catégorie III de mesure est pour des mesures effectuées dans l'installation de bâtiment. Les exemples sont des mesures sur des conseils de distribution, des disjoncteurs, le câblage, y compris des câbles, des barres omnibus, des boîtes de jonction, des commutateurs, des douille-sorties dans l'installation fixe, et l'équipement à l'utilisation industrielle et à un autre équipement,

par exemple. Moteurs stationnaires avec le raccordement permanent à l'installation fixe. La catégorie IV de mesure est pour des mesures effectuées à la source d'installation de basse tension. Les exemples sont des mètres et des mesures de l'électricité sur les dispositifs de protection d'excédent primaire et les unités de commande courants d'ondulation.

## Environnement de fonctionnement

### Opération

de la température : 10°C au non-fonctionnement

de +40°C : - 20°C à l'humidité

de +70°C

sous +35°C : humidité relative +35°C

de ≤90% à +40°C : humidité relative de ≤60%



---

#### EN AVERTISSANT

d'éviter le court-circuit à l'intérieur de l'instrument ou de la décharge électrique, svp ne fonctionnez pas dans l'environnement humide.

---

### Opération

d'altitude : moins de 3 kilomètres

de non-fonctionnement : moins de 15 kilomètres

### La catégorie d'installation (surtension)

ce produit est actionnée par des forces conformément à la catégorie II. d'installation (surtension).



---

#### EN AVERTISSANT

assurez-vous qu'aucune surtension (comme cela provoqué par coup de foudre) ne peut atteindre le produit, ou bien l'opérateur pourrait exposer au danger de la décharge électrique.

---

La catégorie II d'installation de définitions de catégorie d'installation (surtension) (surtension) se rapporte au niveau local de distribution d'énergie qui est applicable à l'équipement relié à la ligne à C.A. (courant alternatif).

## Condition de ventilation

This analyzer uses fan to force cooling. Please make sure that the air intake and exhaust areas are free from obstructions and have free air. When using the analyzer in a bench-top or rack setting, provide at least 10 cm clearance beside, above and behind the instrument for adequate ventilation.

Cet analyzer utilise le ventilateur pour forcer le refroidissement. Veuillez s'assurer que les secteurs d'entrée et d'échappement d'air sont exempts des obstructions et ont l'air libre. À l'aide de l'analyzer dans un mettre hors jeu-dessus ou un arrangement de support, fournissez

---

au moins le dégagement de 10 centimètres près, au-dessus et derrière de l'instrument pour à ventilation proportionnée.



La ventilation insatisfaisante peut causer l'augmentation de la température qui endommagerait l'instrument. Veuillez ainsi la subsistance l'instrument bien aéré lors du fonctionnement et inspectez la prise et éventez régulièrement.

---

## Soin général et nettoyage

Ne stockez pas ou ne laissez pas l'instrument en soleil direct pendant de longues périodes.



Pour éviter d'endommager l'instrument, svp ne les laissez pas dans le brouillard, le liquide, ou le dissolvant.

---

### nettoyage

Veillez exécuter les étapes suivantes pour nettoyer l'instrument régulièrement selon ses conditions de fonctionnement.

1. Démontez l'instrument de toutes les sources d'énergie, et puis nettoyez-le avec un tissu humide mou.
2. Nettoyez la poussière lâche sur l'extérieur de l'instrument avec un tissu mou. En nettoyant l'affichage à cristaux liquides, salut pour éviter de le scarifier.



Pour éviter d'endommager la surface de l'instrument, svp n'utilisez aucune épierreuse corrosive de liquide ou de produit chimique.

---

---



Assurez-vous que l'instrument est complètement sec avant de le remettre en marche pour éviter des courts-circuits ou des blessures.

---

# Allgemeine Sicherheitshinweise

Um Verletzungen oder Schäden am Gerät und den damit verbundenen Produkten zu vermeiden, lesen Sie die folgenden Sicherheitshinweise sorgfältig durch.

Um mögliche Gefahren zu vermeiden, verwenden Sie bitte das Gerät wie angegeben.

**Wartungsarbeiten an diesem Gerät dürfen nur von qualifiziertem Reparaturpersonal durchgeführt werden.**

## Verwendung eines geeigneten Netzkabels

Verwenden Sie nur das für das Gerät vorgesehene und von den örtlichen Behörden zugelassene Netzkabel.

## Erdung des Gerätes

Das Gerät ist über den Schutzleiter des Netzkabels geerdet. Um einen elektrischen Schlag zu vermeiden, vergewissern Sie sich bitte, bevor Sie seine Eingangs- oder Ausgangsklemmen anschließen, dass das Gerät korrekt geerdet ist.

## Anschluss der Signalleitung

Die Masse der Signalleitung ist auf dem gleichen Potential wie die Erdung des Gerätes. Schließen Sie daher die Masseleitung nie an eine Hochspannung an. Berühren Sie keine freiliegenden Kontakte oder Komponenten.

## Verschaffen Sie sich einen Überblick über alle Anschluss-Ratings

Um Brände oder Stromschläge zu vermeiden, lesen Sie bitte alle Bemerkungen und Anweisungen des Gerätes. Bevor Sie das Gerät anschließen, lesen Sie bitte das Handbuch sorgfältig durch, um weitere Informationen über die Nennleistungen zu erhalten.

## Betreiben Sie kein Gerät, bei dem der Verdacht besteht, dass es defekt ist.

Wenn Sie vermuten, dass das Produkt beschädigt ist, lassen Sie es bitte von qualifiziertem Fachpersonal überprüfen. Vermeiden Sie den Kontakt mit freiliegenden Stromkreisen oder Drähten. Berühren Sie keine freiliegenden Kontakte oder Komponenten, wenn das Gerät eingeschaltet ist.

## Verwenden Sie einen geeigneten Überspannungsschutz

Stellen Sie sicher, dass keine Überspannung (z.B. durch ein Gewitter) auf das Produkt gelangen kann, da sonst der Bediener der Gefahr eines Stromschlags ausgesetzt sein kann.

## Nicht ohne Abdeckungen betreiben

Betreiben Sie das Gerät nicht bei abgenommenen Abdeckungen oder Platten.

## Halten Sie die Oberfläche des Gerätes sauber und trocken.

## Nicht unter nassen/feuchten Bedingungen betreiben.

Betreiben Sie das Gerät nicht in einer explosiven Atmosphäre.

Vermeiden Sie es, dieses Gerät einem Feuer auszusetzen.

## Sicherheitshinweise und Symbole

In diesem Produkt verwendete Begriffe. Diese Begriffe können im Produkt erscheinen:

**GEFAHR** weist auf eine mögliche, sofortige und direkte Verletzung oder Gefährdung hin.

**WARNUNG** weist auf möglicherweise auftretende Verletzungen oder Gefahren hin

**VORSICHT** weist auf möglicherweise auftretende Schäden am Gerät oder anderen Gegenständen hin

In diesem Produkt verwendete Symbole. Diese Symbole können auf dem Produkt erscheinen:



Gefährliche  
Spannung



Schutzerde



Sicherheitswarnung

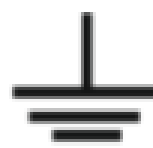

Erdung



Netzschalter

# Contents

Copyright and Declaration .....	II
Safety Information.....	III
General Safety Summary .....	III
Safety Terms and Symbols.....	IV
Measurement Category .....	V
Working Environment .....	VI
Ventilation Requirement .....	VII
General Care and Cleaning.....	VII
L'information de sûreté .....	VIII
Résumé général de sûreté .....	VIII
Limites et symboles de sûreté.....	X
Catégorie de mesure .....	XI
Environnement de fonctionnement .....	XII
Condition de ventilation .....	XII
Soin général et nettoyage .....	XIII
Allgemeine Sicherheitshinweise .....	XIV
Sicherheitshinweise und Symbole.....	XV
Chapter 1 Quick Start .....	0
1.1 General Inspection .....	1
1.2 Appearance and Dimension .....	1
1.3 Preparing for Use .....	2
1.3.1 Adjust the Supporting Legs .....	2
1.3.2 Connect to AC Power Supply .....	2
1.4 The Front Panel.....	3
1.4.1 Front Panel Function Keys .....	3
1.4.2 Front Panel Key Backlight .....	4
1.4.3 Using the Numeric Keyboard.....	5
1.4.4 Front Panel Connectors.....	6
1.5 Rear Panel.....	7
1.6 Display Annotations .....	9
1.7 Firmware Operation.....	10
1.7.1 System Information Check .....	10
1.7.2 Enable Option .....	11
1.7.3 Firmware Upgrade.....	11
1.8 Menu Operation.....	11
1.9 Parameter Setting.....	12
1.10 Using Built-in Help .....	13
1.11 Using the Security Lock.....	13
Chapter 2 Front Panel Operation .....	14
2.1 Basic Settings .....	15
2.1.1 Frequency.....	15
2.1.2 Span.....	18



---

2.1.3	Amplitude .....	20
2.1.4	Auto Tune.....	23
2.2	Sweep and Functions .....	25
2.2.1	BW .....	25
2.2.2	Trace .....	27
2.2.3	Detect.....	29
2.2.4	Sweep .....	30
2.2.5	Trigger.....	32
2.2.6	Limit .....	33
2.2.7	TG (Tracking Generator) .....	34
2.2.8	Demod .....	37
2.3	Marker.....	39
2.3.1	Marker.....	39
2.3.2	Marker -> .....	42
2.3.3	Marker Fn.....	43
2.3.4	Peak.....	46
2.4	Measurement.....	48
2.4.1	Meas .....	48
2.4.2	Meas setup .....	49
2.5	System.....	56
2.5.1	System .....	56
2.5.2	Display .....	58
2.5.3	File .....	59
2.6	Shortcut Key .....	62
2.6.1	Preset.....	62
2.6.2	Couple.....	65
2.6.3	Help.....	65
2.6.4	Save.....	65
Chapter 3	Remote Control.....	66
3.1	Remotely Operating the Analyzer.....	66
3.1.1	Connecting the Analyzer via the USB Device port.....	66
3.1.2	Connecting the Analyzer via the LAN port .....	66
3.1.3	Connecting the Analyzer via the USB Host port.....	67
3.2	Build Communication.....	68
3.2.1	Build Communication Using VISA .....	68
3.2.2	Build Communication Using Sockets/Telnet.....	70
3.3	Remote Control Capabilities.....	70
3.3.1	User-defined Programming .....	70
3.3.2	Send SCPI Commands via NI MAX .....	71
3.3.3	EasySpectrum Software .....	73
Chapter 4	Troubleshooting and Service .....	75
4.1	Service Summary .....	75
4.2	Troubleshooting .....	75
4.3	Contact Us .....	77

---

# Chapter 1 Quick Start

This chapter guides users to quickly get familiar with the appearance, dimensions, front/ rear panel and the user interface, as well as announcements during first use of SSA3000X series spectrum analyzer.

Subjects in this chapter:

- ◆ General Inspection
- ◆ Appearance and Dimension
- ◆ Preparing for Use
- ◆ The Front Panel
- ◆ Rear Panel
- ◆ Display Annotations
- ◆ Firmware Operation
- ◆ Menu Operation
- ◆ Parameter Setting
- ◆ Using Built-in Help
- ◆ Using the Security Lock

## 1.1 General Inspection

### 1. Inspect the shipping container

Keep the damaged shipping container or cushioning material until the contents of the shipment have been completely checked and the instrument has passed both electrical and mechanical tests.

The consigner or carrier will be responsible for damages to the instrument resulting from shipment. **SIGLENT** will not provide free maintenance or replacement.

### 2. Inspect the instrument

If the instrument is found to be damaged, defective or fails in electrical or mechanical tests, please contact **SIGLENT**.

### 3. Check the accessories

Please check the accessories according to the packing list. If the accessories are incomplete or damaged, please contact your **SIGLENT** sales representative.

## 1.2 Appearance and Dimension

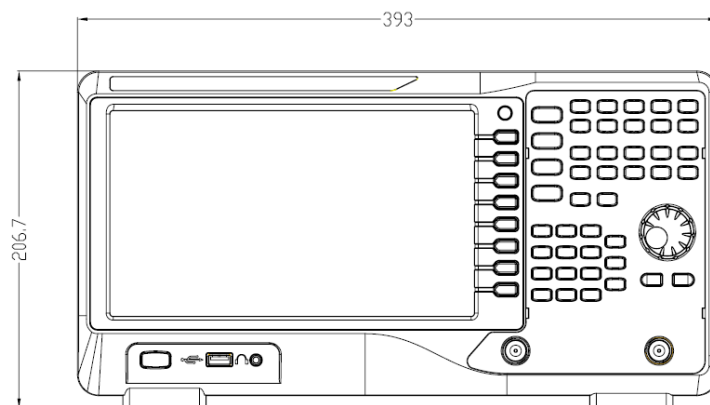

Figure 1-1 Front View

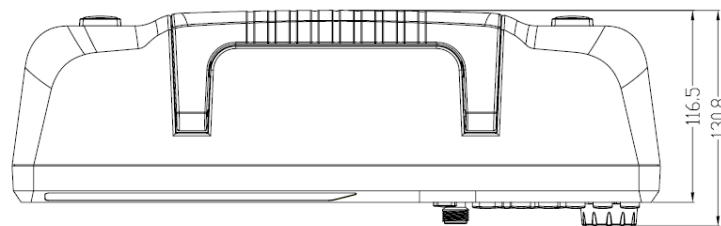

Figure 1-2 Top View

## 1.3 Preparing for Use

### 1.3.1 Adjust the Supporting Legs

Adjust the supporting legs properly to use them as stands to tilt the Spectrum Analyzer upwards for stable placement as well as easier operation and observation of the instrument.

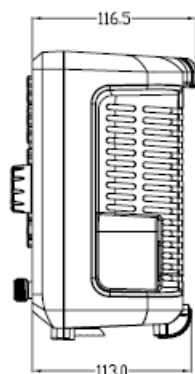

Figure 1-3 Before adjusting

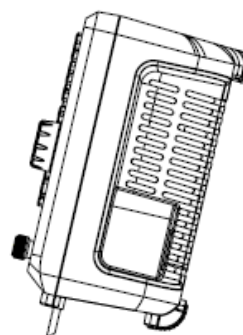

Figure 1-4 After adjusting

### 1.3.2 Connect to AC Power Supply

The spectrum analyzer accepts 100-240V, 50/60/440Hz AC power supply. Please use the power cord provided as accessories to connect the instrument to the power source as shown in the figure below. Before power on, make sure the spectrum analyzer is protected by fuse.

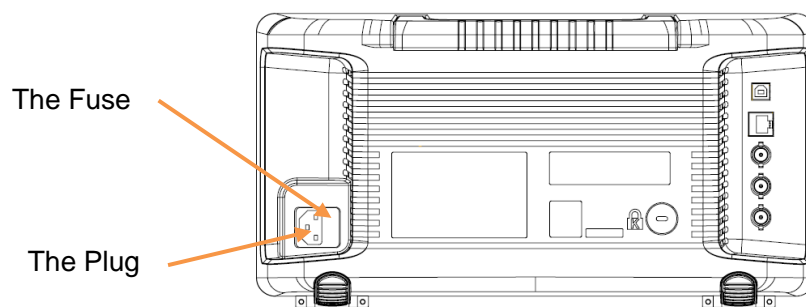

Figure 1-5 Power Cord Connection

## 1.4 The Front Panel

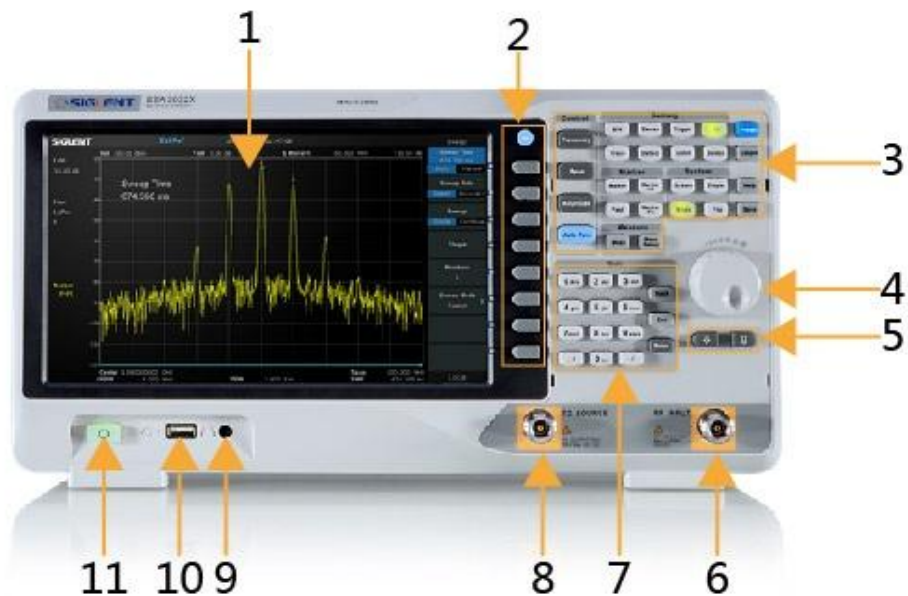

Figure 1-6 the Front Panel

Table 1-1 Front Panel Description

NO.	Description	NO.	Description
1	User Graphical Interface	2	Menu Control Keys
3	Function Keys	4	Knob
5	Arrow Keys	6	RF Input
7	Numeric Keyboard	8	TG Output
9	Earphone interface	10	USB Host
11	Power Switch		

### 1.4.1 Front Panel Function Keys

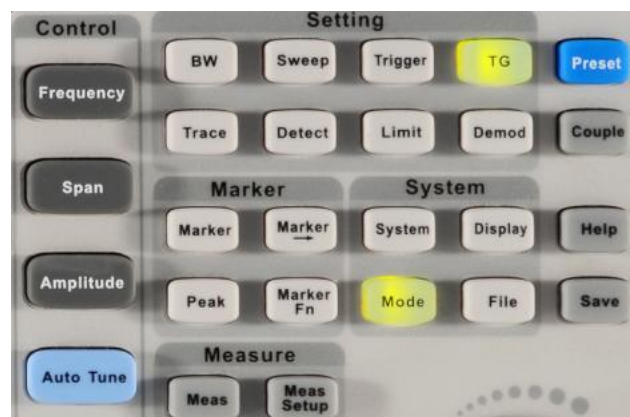

Figure 1-7 Function Keys area

Table 1-2 Function keys description

Control Keys	Description
<b>Frequency</b>	Set the parameters of frequency, and Peak→CF, CF→Step.
<b>Span</b>	Set the parameters of span, and X-scale (Log-Linear) setup.
<b>Amplitude</b>	Set the parameters of amplitude, including Ref Level, Attenuator, Preamp, etc; and Correction setup.
<b>Auto Tune</b>	Scan the full span rapidly and move the biggest signal to center freq, and automatically sets the optimal parameters according to the signal.
Control Keys	Description
<b>BW</b>	Set the parameters of RBW and VBW, Average Type (Log power, Power, Voltage), and Filter Type (-3 dB Gauss\ -6 dB EMI).
<b>Trace</b>	Select Trace, Trace setup and Trace math.
<b>Sweep</b>	Set the parameters of sweep, and EMI QPD Dwell Time.
<b>Detect</b>	Select the Detector type for each trace independently.
<b>Trigger</b>	Select triggers in Free Trigger, Video Trigger and External Trigger.
<b>Limit</b>	Set the Pass\Fail Limit.
<b>TG</b>	Set the parameters of tracking generator. Including TG Level, TG level offset, Normalization setup. The backlight LED is on when TG source is on.
<b>Demod</b>	Set the demodulation parameters of the AM and FM for audio listening
Marker Keys	Description
<b>Marker</b>	Set the Markers and Marker Table
<b>Marker-&gt;</b>	Set other system parameters on the basis of the current marker value.
<b>Marker Fn</b>	Special functions of the marker such as noise marker, N dB bandwidth measurement and frequency counter.
<b>Peak</b>	Search for the peak signal, peak search configuration and peak table.
Meas Keys	Description
<b>Meas</b>	In spectrum analyzer mode, select the Advanced Measurement function In non spectrum analyzer mode, select corresponding settings.
<b>Meas Setup</b>	Set the measurement parameters.
System Keys	Description
<b>System</b>	Set the system parameters
<b>Mode</b>	Select the working mode between spectrum analyzer and other modes.
<b>Display</b>	Set the display parameters.
<b>File</b>	Use the file system and files
Shortcut Keys	Description
<b>Preset</b>	Sets the system to certain status
<b>Couple</b>	Set the parameters of some functions between auto and manual.
<b>Help</b>	Turn on the built-in help
<b>Save</b>	Save Shortcut Key

## 1.4.2 Front Panel Key Backlight

The on/off state and the color of the backlights of some keys at the front panel indicate the working

state of the spectrum analyzer. The states are as listed below.

### 1. Power Switch

- ◆ Flash on and off alternatively, in breathing state: indicate the unit is in stand-by state.
- ◆ Constant on: indicate the instrument is in normal operating state.

### 2. **Mode**

When the function is **Spec Analyzer**, the backlight is turn off. When in the other mode, the backlight of Mode turns on.

### 3. **TG**

When the **TG** source is on, the backlight of **TG** turns on and turns off when the function is off.

## 1.4.3 Using the Numeric Keyboard

The analyzer provides a numeric keyboard at the front panel (as shown in the figure below). The numeric keyboard which supports English uppercase/lowercase characters, numbers and common symbols (including decimal point, #, space and +/-) are mainly used to edit file or folder name and set parameters (refer to “**Parameter Setting**”).

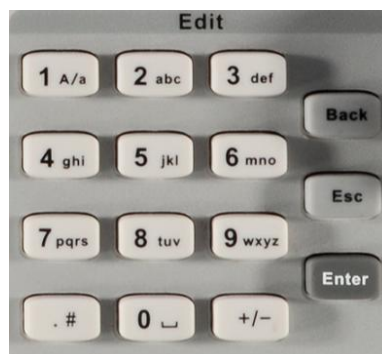

Figure 1-8 Numeric Keyboards

#### 1. **+/-**

In number input, set the sign of number; in file input, switch in number and letter.

#### 2. **1 A/a**

In number input, enter number 1; in file input, switch between uppercase and lowercase letter.

#### 3. **. #**

In number input, a decimal point. In English input, special character.

#### 4. **Back**

In parameter editing, press this key to delete the character on the left of the cursor.

#### 5. **Esc**

- ◆ During parameter editing process, press this key to clear the inputs in the active function area and exit parameter input.

- ◆ When the instrument is in remote mode, use this key to return to local mode.

6. **Enter**

In parameter editing, the system will complete the input and insert a default unit for the parameter.

### 1.4.4 Front Panel Connectors

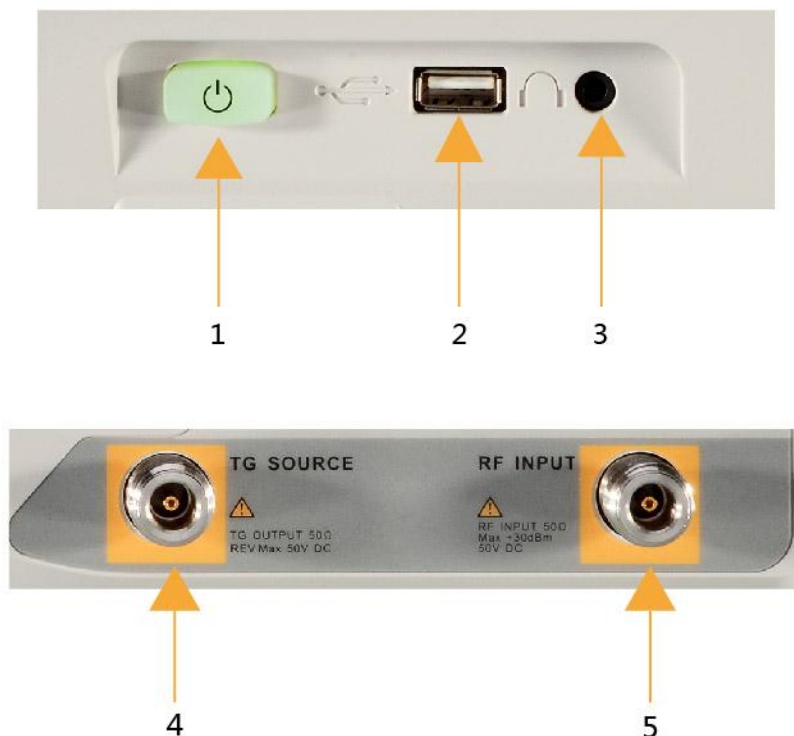

Figure 1-9 Front Panel Connectors

1. **Power Switch** 

Power up / Power down the instrument.

2. **USB Host**

- ◆ The analyzer can serve as a “host” device to connect external USB devices. This interface is available for USB storage devices.
- ◆ Read and store the instrument state or trace in the USB storage device or store the contents currently displayed on the screen in the USB storage device in .png or .jpg or .bmp format.

3. **Earphone Jack**

The analyzer provides AM and FM demodulations. Insert the earphone to the jack to acquire the audio output of the demodulated signal. You can turn on or off the earphone output and adjust the volume via **Demod** -> **Volume**.

**CAUTION**





---

For fear of damaging your hearing, please turn the volume down to zero and gradually turn the volume up after putting on the earphone.

---

#### 4. TG SOURCE

The TG SOURCE can be connected to a receiver through a cable with an N-male connector.



#### CAUTION

To avoid damage to the tracking generator, the reverse DC voltage cannot exceed 50 V

---

#### 5. RF INPUT

The RF INPUT can be connected to a DUT through a cable with an N-male connector.



#### CAUTION

To avoid damage to the instrument, for the signal input from the RF input terminal, the DC voltage component and the maximum continuous power of the AC (RF) signal component cannot exceed 50 V and +30 dBm respectively.

---

## 1.5 Rear Panel



Figure 1-10 Rear Panel

#### 1. Handle

Pull up the handle vertically for easy carrying of the instrument. When you do not need the handle, press it down.

## 2. USB Device Interface

The analyzer can serve as a “slave” device to connect external USB devices. Through this interface, a PC can be connected to control the analyzer remotely through programming or PC software.

## 3. LAN Interface

Through this interface, the analyzer can be connected to your local network for remote control.

## 4. REF IN 10MHz

The analyzer can use internal or external reference source.

- ◆ When a 10 MHz external clock signal is received through the **[10MHz IN]** connector, this signal is used as the external reference source and “**Ext Ref**” is displayed in the status bar of the user interface. When the external reference is lost, transfinite or not connected, the instrument switches to its internal reference source automatically and “**Ext Ref**” on the screen disappears.
- ◆ The **[10MHz IN]** and **[10MHz OUT]** connectors are usually used to build synchronization among multiple instruments.

## 5. REF OUT 10MHz

The analyzer can use internal or external reference source.

- ◆ When internal reference source is used, the **[10MHz OUT]** connector can output a 10 MHz clock signal generated by the analyzer. This signal can be used to synchronize other instruments.
- ◆ The **[10MHz OUT]** and **[10MHz IN]** connectors are usually used to build synchronization among multiple instruments.

## 6. Trigger in

In external trigger mode, the connector receives an external trigger signal through a BNC cable.

## 7. Security Lock Hole

If needed, you can use a security lock (buy it yourself) to lock the analyzer to a desired location.

## 8. AC Power Supply and Fuse

The analyzer accepts 100-240V, 50/60/440Hz AC power supply. Please use the power cord provided as accessories to connect the instrument. Before power on, make sure the spectrum analyzer is protected by fuse.

## 1.6 Display Annotations

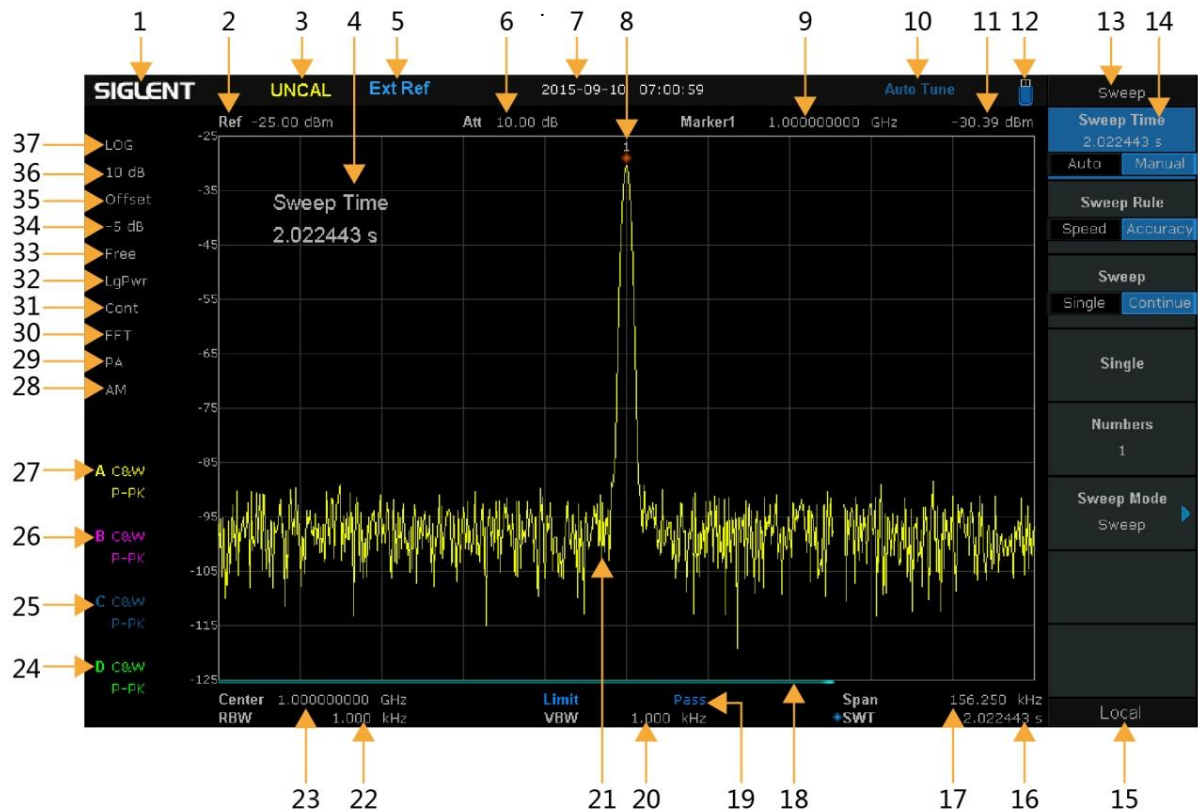

Figure 1-11 User Interface

Table 1-3 User Interface labels

NO.	Name	Description
1	SIGLENT	Logo of SIGLENT
2	Ref	Reference level
3	UNCAL	When the sweep time less than the auto couple time, the measure result may be inaccuracy, then appear "UNCAL"
4	Active function area	Current parameter and its value
5	EXT REF	Ext 10 MHz reference clock detected indicator
6	Att	Attenuator Value
7	Day and time	System time
8, 9, 11	Maker parameter	8:current active marker; 9:current marker frequency value; 11:current marker amplitude value;
10	Auto Tune	Automatically sets the optimal parameters
12	USB storage device identification	The identification is displayed when a USB disk is inserted
13	Menu title	Function of the current menu.
14	Menu items	Menu items of the current function
15	Operation status	Local is local mode, Remote is remote mode, Upgrade

		means the instrument is upgrading
16	Sweep time	Sweep time
17	Span/Stop Frequency	The frequency range of the current sweep
18	Sweep progress bar	Sweep progress bar
19	Pass/Fail status	Pass/Fail status
20	VBW	Video bandwidth
21	Spectrum trace	Spectrum trace
22	RBW	Resolution bandwidth
23	Center/Start frequency	The frequency range of the current sweep
24, 25, 26, 27	Trace status	Set the trace A\B\C\D parameter. Trace type ---- C&W: Clear Write, MaxH: Max Hold, MinH: Min Hold, View: View, AVG: Average and times. Detect type ---- P-PK: Positive peak, N-PK: Negative peak, Samp: Sample, Norm: Normal, AVG: Average. Q-PK: Quasi peak
28	AM or FM	AM or FM identification
29	PA	Enable or disable Preamplifier
30	FFT	Sweep mode is FFT
31	Single or Continue	Sweep mode single or continue
32	Average type	Log power, Power, Voltage
33	Trigger type	Free, Video, External trigger
34, 35	Ref offset	34: Ref offset identification; 35: Ref offset value
36	Scale/Div	Scale value
37	Scale type	Logarithm or linearity

## 1.7 Firmware Operation

### 1.7.1 System Information Check

Users can get the system information by press **System**->“**System Info**”, including

- ◆ Product Model, Serial and Host ID
- ◆ Software Version and Hardware Version
- ◆ Option Information

## 1.7.2 Enable Option

Refer to the procedures below to activate the options you have purchased.

- 1, Press **System** ->“Load Option”
- 2, Enter the license key in the onscreen window. Press **Enter** to confirm your input and terminate the license key input. Or
- 3, Load the .lic file provided by pressing **File** ->“Load” from internal memory or USB stick. The option will be enabled after rebooting.

## 1.7.3 Firmware Upgrade

Follow this procedure to finish the firmware update:

- 1, Download the firmware package from website.
- 2, Extract and copy the .ADS file into the root directory of a USB stick.
- 3, Plug the USB stick into the USB Host connector. Press **System**->“System Info”-> “Firmware Update”, find the .ADS file in USB stick.
- 4, Press “Load”. The analyzer will perform the update process automatically.

The upgrade procedure will take several minutes. Once the upgrade is completed, please follow the instruction to reboot.

Any interruption during the update process will result in update failure and system data lost. Do not remove the USB storage device until the update is finished.

## 1.8 Menu Operation

There are 7 types of menus according to their operation modes. Each type of menu and its operation method are introduced below.

### 1. Parameter Input

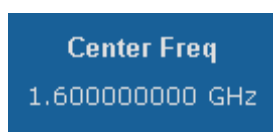

When selected, use the numeric keys to modify the parameters. For example, select **Center Freq**, input the desired figure and press **Enter** to change the center frequency.

### 2. State switching

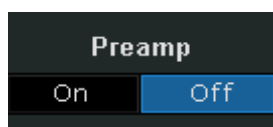

Press the corresponding menu key to switch between the sub-options.

For example, press **Preamp** to enable or disable the amplifier.

### 3. Enter Lower Menu(with parameter)

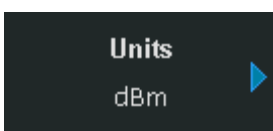

Press the corresponding menu key to enter the lower menu and change the option currently selected.

For example, press **Units** to enter the lower menu. Select **dBm** and return to the previous menu. The unit of Y-axis changes to dBm.

**4. Enter Lower Menu (without parameter)**

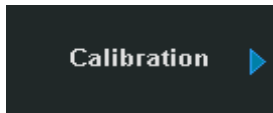

Press the corresponding menu key to enter the lower menu.  
For example, press **Calibration** to enter the lower menu directly.

**5. Direct Execution**

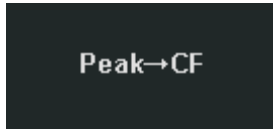

Press the key to execute the corresponding function.  
For example, press **Peak->CF** to execute a peak search and set the center frequency of the analyzer to the frequency of the current peak signal.

**6. Function Switch + Parameter Input**



Press the corresponding menu key to switch between functions; change the parameter directly using the numeric keys.  
For example, press **Freq Step** to switch between **Auto** and **Manual**; if **Manual** is selected, you can directly input the desired number to change the Freq Step.

**7. State Selection**



Press the corresponding menu key to modify the parameter and return to the menu one level up.  
For example, press **Trig Type ->Free Run** to select free trigger and the analyzer is in Free Run state at present.

## 1.9 Parameter Setting

Users can enter the desired parameter values using the numeric keys, knob or Arrow keys. This section describes the three methods of parameter setting through an example (to set the center frequency to 100 MHz).

**1. Use the numeric keyboard**

- ◆ Press **Frequency**->**Center Freq**
- ◆ Input 100 using the numeric keys;
- ◆ Select the desired unit (MHz) from the popup menu.

**2. Use the knob**

When the parameter is editable (namely when the parameter is selected), turn the knob clockwise to increase or counterclockwise to decrease the parameter value at the specified step.

- ◆ Press **Frequency**->**Center Freq**
- ◆ Rotate the knob until the parameter is set to the desired value (100 MHz).



Figure 1-12 Knob

### 3. Use the arrow keys

When the parameter is editable (namely when the parameter is selected), you can increase or decrease the parameter value at the specific step using the direction keys.

- ◆ Press **Frequency** -> “Center Freq”
- ◆ Press the up/down Arrow key until the parameter is set to the desired value (100 MHz).

## 1.10 Using Built-in Help

The built-in help system provides information about every function key at the front panel and every menu soft key.

- ◆ Press **Help** and a prompt about how to obtain help information will be shown at the center of the screen. Then, press the key that you want to get help of and the relevant help information will be shown at the center of the screen.
- ◆ When the help information show at the center of the screen. Press the **Help** button; it will close the help information.

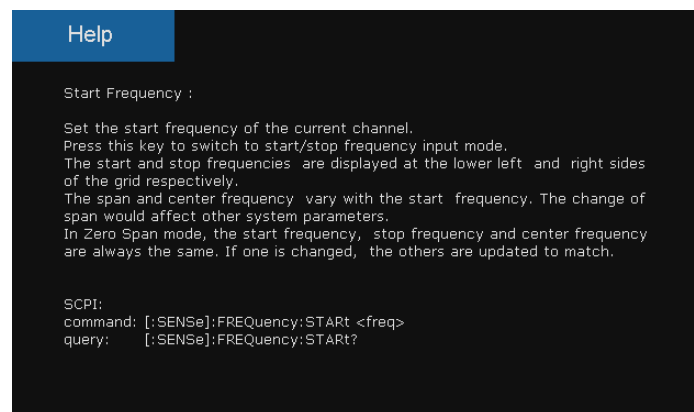

Figure 1-13 help information

## 1.11 Using the Security Lock

If needed, you can use the security lock (please buy it yourself) to lock the Spectrum Analyzer to a fixed location. The method is as follows, align the lock with the lock hole and plug it into the lock hole vertically, turn the key clockwise to lock the Spectrum Analyzer and then pull the key out.

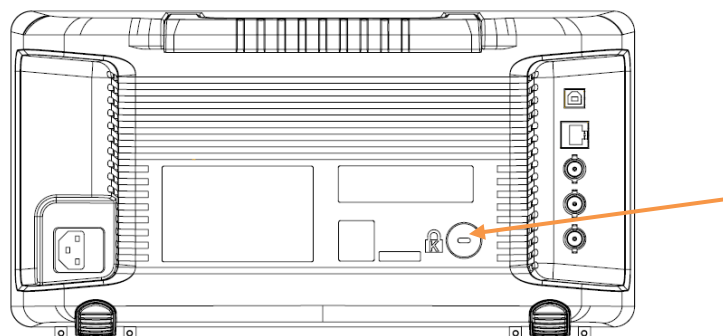

Figure 1-14 Security Lock

# Chapter 2 Front Panel Operation

This chapter describes in detail the function keys at the front panel and the associated functions.

Subjects in this chapter:

- ◆ Basic Settings
- ◆ Sweep and Function
- ◆ Marker
- ◆ Measurement
- ◆ System
- ◆ Shortcut Key



## 2.1 Basic Settings

### 2.1.1 Frequency

Set the frequency parameters and functions of the analyzer. Restart sweeping every time when the frequency parameters are modified.

The frequency range of a channel can be expressed by either of three groups of parameters: Start Frequency, Center Frequency and Stop Frequency. If any of the parameters is changed, the others would be adjusted automatically in order to ensure the coupling relationship among them

$$f_{\text{center}} = (f_{\text{start}} + f_{\text{stop}})/2, \text{ The } f_{\text{span}} \text{ is span.}$$

$$f_{\text{span}} = f_{\text{stop}} - f_{\text{start}}$$

#### 2.1.1.1 Center Frequency

Set the center frequency of the current channel. The center frequency and span values are displayed at the lower left and right sides of the grid respectively. In process of using pay attention to the following points:

- ◆ The start and stop frequencies vary with the center frequency when the span is constant (except the Start Frequency and Stop Frequency to the border).
- ◆ In Zero Span, the start frequency, stop frequency and center frequency are always the same.

Table 2-1 Center Frequency

Parameter	Explanation
Default	Full Span/2
Range	Zero Span, 0 Hz ~ Full Span Nonzero Span, 50 Hz ~ (Full Span -50Hz)
Unit	GHz\MHz\kHz\Hz
Knob Step	Span>0, step=Span/200 Span=0, step=RBW/100 Min 1 Hz
Direction Key Step	Freq step
Related to	Start Freq, Stop Freq

#### 2.1.1.2 Start Frequency

Set the start frequency of the current channel. The start and stop frequencies are displayed at the lower right sides of the grid respectively. In process of using pay attention to the following points:

- ◆ The span and center frequency vary with the start frequency when the Span did not reach the minimum (The parameters vary with the span, please refer to “**Span**”);
- ◆ In Zero Span, the start frequency, stop frequency and center frequency are always the same.

Table 2-2 Start Frequency

Parameter	Explanation
Default	0 GHz
Range	Zero Span, 0 Hz ~ Full Span Nonzero Span, 0 Hz ~ (Full Span-100Hz)
Unit	GHz\MHz\kHz\Hz
Knob Step	Span>0, step=Span/200 Span=0, step=RBW/100 Min 1 Hz
Direction Key Step	Freq step
Related to	Center Freq, Span

### 2.1.1.3 Stop Frequency

Set the stop frequency of the current channel. The start and stop frequencies are displayed at the lower right sides of the grid respectively. In process of using pay attention to the following points:

- ◆ The span and center frequency vary with the stop frequency. The change of span would affect other system parameters. For more details, please refer to “**Span**”.
- ◆ In Zero Span mode, the start frequency, stop frequency and center frequency are always the same.

Table 2-3 Stop Frequency

Parameter	Explanation
Default	Full Span
Range	Zero Span: 0 Hz ~ Full Span Nonzero Span: 100 Hz ~ Full Span
Unit	GHz, MHz, kHz, Hz
Knob Step	Span>0, step=Span/200 Span=0, step=RBW/100 Min 1 Hz
Direction Key Step	Freq step
Related to	Center Freq, Span

### 2.1.1.4 Freq Step

Set the step of the center frequency. Start frequency and stop frequency vary with the step frequency through arrow keys. In process of using pay attention to the following points:

- ◆ At a fixed step change the value of the center frequency can reach the purpose of continuous measurement channel switch.
- ◆ There are two kinds of frequency step mode: **Auto** and **manual**. In Auto mode, the Freq step is 1/10 of the span in Non-zero span mode or equals the RBW while in Zero span mode; in Manual mode; you can set the step using the numeric keys.

Table 2-4 Frequency step

Parameter	Explanation
Default	Full Span/10
Range	1Hz ~ Full Span
Unit	GHz, MHz, kHz, Hz
Knob Step	Span>0, Step=Span/200 Span=0, Step=100 min 1 Hz
Direction Key Step	1-2-5 sequence step
Relation	RBW, Span and related parameters

### 2.1.1.5 Peak -> CF

Execute a peak search and use the frequency of the current peak as the center frequency (CF) of the analyzer. The function is invalid in Zero Span mode.

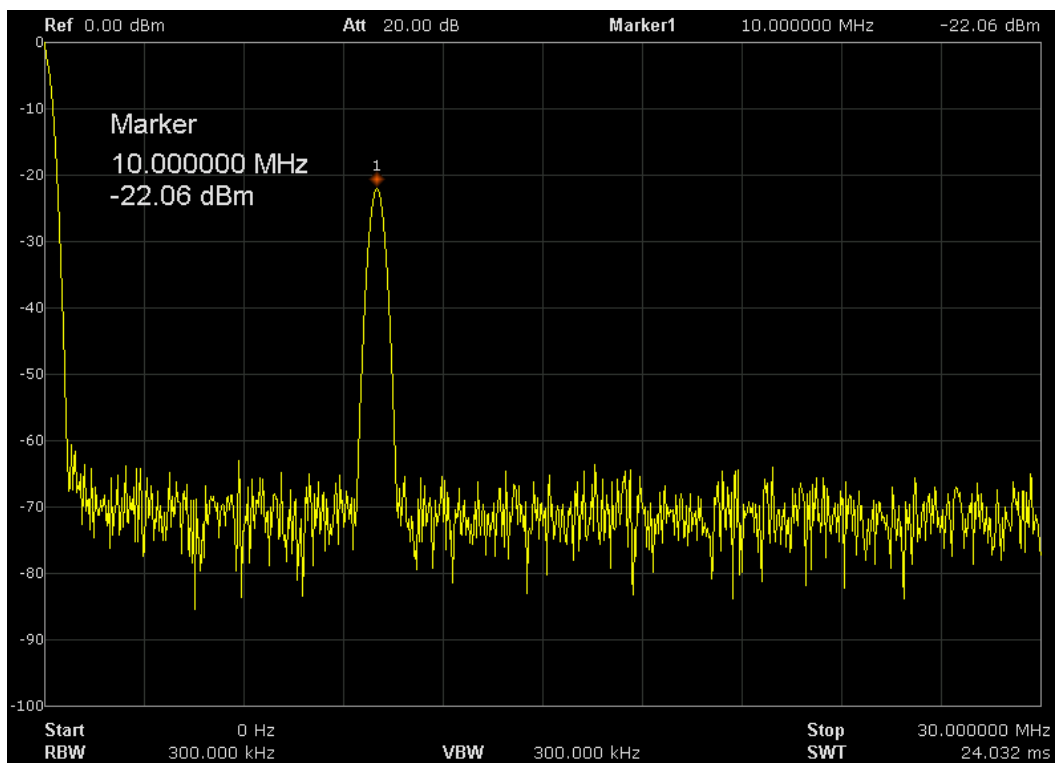

Figure 2-1 before Peak -> CF

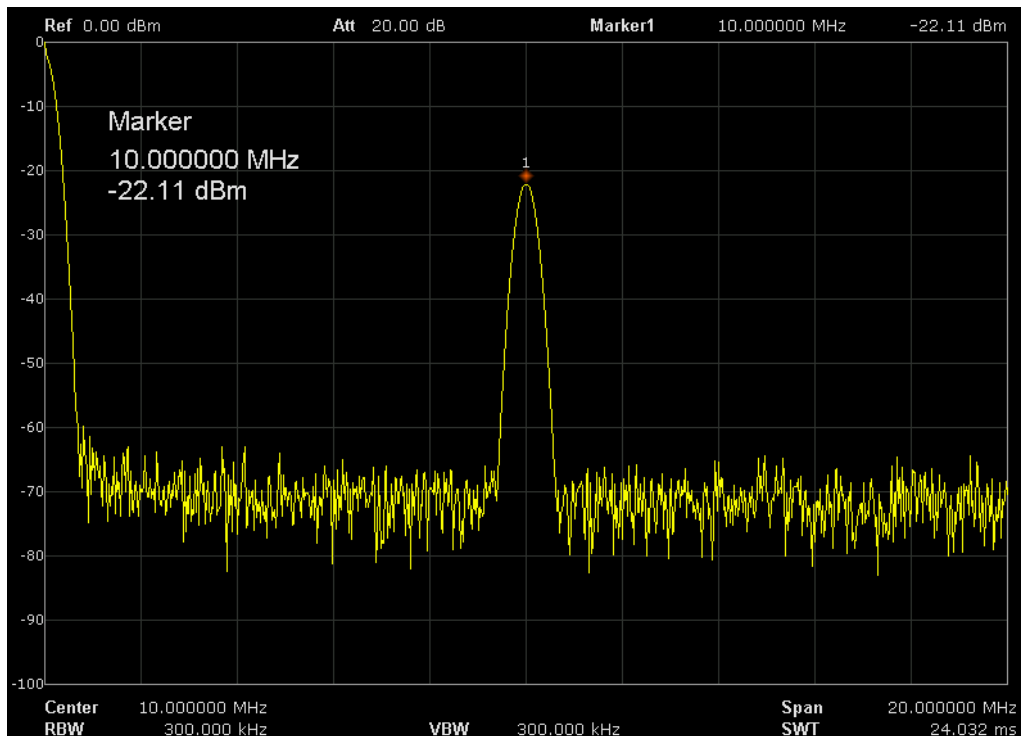

Figure 2-2 after Peak -&gt; CF

### 2.1.1.6 CF -> Step

Set the current center frequency as the CF step. At this point, the CF step will switch to “**Manual**” mode automatically. This function is usually used with channel switching. Take harmonic waveform measurement for example: locate a signal at the center frequency of a channel, execute CF->Step and then press the down direction key continuously to measure each order of harmonic in sequence

## 2.1.2 Span

Set the span of the analyzer. The change of this parameter will affect the frequency parameters and restart the sweep.

### 2.1.2.1 Span

Set the frequency range of the current channel. The center frequency and span are displayed at the low left and right sides of the grid respectively. In process of using pay attention to the following points:

- ◆ The start and stop frequency vary with the span when the center frequency is constant.
- ◆ In manual span mode. The span can be set down to 100Hz and up to the full span described in Specifications. When the span is set to the maximum, the analyzer enters full span mode.
- ◆ Modifying the span in non-zero span mode may cause an automatic change in both CF step and RBW if they are in Auto mode. Besides, the charge of RBW may influence VBW (in Auto

- VBW mode).
- ◆ Variation in the span, RBW or VBW would cause a change in the sweep time.
  - ◆ In non-zero span mode, neither is “**Video**” trigger nor “**1/Δ time**” readout function valid.

Table 2-5 Span

Parameter	Explanation
Default	Maximum bandwidth
Range	0 Hz~ 3.2 GHz
Unit	GHz, MHz, kHz, Hz
Knob Step	Span/200, Min = 1 Hz
Direction Key Step	In 1-2-5 sequence
Related to	Start Freq, Stop Freq, Freq Step, RBW, Sweep time

Note: 0 Hz is available only in zero span.

### 2.1.2.2 Full Span

Set the span of the analyzer to the maximum.

### 2.1.2.3 Zero Span

Set the span of the analyzer to 0Hz. Both the start and stop frequencies will equal the center frequency and the horizontal axis will denote time. The analyzer measures the time domain characteristics of the amplitude of the corresponding frequency point on the input signal. In process of using pay attention to the following points:

The following functions are invalid in Zero span mode: Peak ->CF, Signal Track, Zoom In and Zoom Out.

- ◆ **Frequency**: Peak->CF;
- ◆ **SPAN**: Zoom In and Zoom Out;
- ◆ **Marker->**: M ->CF, M->CF step, M->Start Freq, M->Stop Freq, Δ M->CF and Δ M->Span;
- ◆ **Marker**: Frequency, Period and 1/Δ Time(valid in Delta marker type);

### 2.1.2.4 Zoom In

Set the span to half of its current value. At this point, the signal on the screen is zoomed in to observe signal details.

### 2.1.2.5 Zoom Out

Set the span to twice the current value. At this point, the signal on the screen is zoomed out to gain more information about the signal.

### 2.1.2.6 Last Span

Set the span to the previous span setting.

### 2.1.2.7 X-Scale

Set the scale type of X-axis to Lin or Log.

In Log scale type, the frequency scale of X-axis is displayed in the logarithmic form.

If the scale type of X-axis is in the logarithmic type form, the scale type will be switched into Lin when turning on Meas.

## 2.1.3 Amplitude

Set the amplitude parameters of the analyzer. Through modifying these parameters, signals under measurement can be displayed in a proper mode for easier observation and minimum error.

### 2.1.3.1 Ref Level

Set the maximum power or voltage can be currently displayed in the window. The value is displayed at the upper left corner of the screen grid.

The maximum reference level available is affected by the maximum mixing level; input attenuation is adjusted under a constant maximum mixing level in order to fulfill the following condition:

$$\text{Ref} \leq \text{ATT} - \text{PA} - 20\text{dBm}$$

Table 2-6 Ref Level

Parameter	Explanation
Default	0 dBm
Range	-100 dBm ~ 30 dBm
Unit	dBm, dBmV, dBuV, V, W
Knob Step	In Log scale mode, step = Scale/10 In Lin scale mode, step = 0.1 dB
Direction Key Step	In Log scale mode, step = Scale In Lin scale mode, step = 1 dB
Related to	Attenuator, Preamp, Ref Offset

### 2.1.3.2 Attenuator

Set the front attenuator of the RF input in order to ensure big signals (or small signals) to pass through the mixer with low distortion (or low noise).

$$\text{Ref} \leq \text{ATT} - \text{PA} - 20\text{dBm}$$

Input attenuation can be set up for automatic and manual two kinds of patterns.

- ◆ Automatic mode attenuation value according to the state of preamplifier and value of the

current reference level automatic adjustment.

- ◆ Open the preamplifier; maximum input attenuation can be set to 51dB. When setting parameters do not meet the above formula, can adjust the reference level.

Table 2-7 Attenuator

Parameter	Explanation
Default	20 dB
Range	0 ~ 51 dB
Unit	dB
Knob Step	1 dB
Direction Key Step	5 dB
Related to	Preamp, Ref level

### 2.1.3.3 RF Preamp

Turn on or off the preamplifier located at the front of the RF signal path. When signal under measurement is small, turning on the preamplifier can reduce the displayed noise level; there for, you can distinguish small signals from the noise.

The corresponding icon “PA” will appear at the left side of the screen when the preamplifier is turned on.

### 2.1.3.4 Units

Set the unit of the Y-axis to dBm, dBmV, dBuV, Volts (RMS) and Watts. The default is dBm.

The conversion relationships between units are as follows.

$$\text{dBm} = 10\lg\left(\frac{\text{Volts}^2}{R} \times \frac{1}{1\text{mW}}\right)$$

$$\text{dB}\mu\text{V} = 20\lg\left(\frac{\text{Volts}}{1\mu\text{V}}\right)$$

$$\text{dBmV} = 20\lg\left(\frac{\text{Volts}}{1\text{mV}}\right)$$

$$\text{Watts} = \frac{\text{Volts}^2}{R}$$

Wherein, R denotes the reference resistance. Default value is 50Ω, setting by “Correction -> RF input”. The “75 Ω” resistance is just a numeric value, not a real resistance.

### 2.1.3.5 Scale

Set the logarithmic units per vertical grid division on the display. This function is only available

when the scale type is set to “log”. In process of using pay attention to the following points:

- ◆ By changing the scale, the amplitude range available is adjusted.
- ◆ The Minimum range: reference level –10 x current scale value;
- ◆ The Maximum range: the reference level.

Table 2-8 Scale

Parameter	Explanation
Default	10 dB
Range	1 dB ~ 20 dB
Unit	dB
Knob Step	1 dB
Direction Key Step	1-2-5 sequence
Related to	Scale Type

### 2.1.3.6 Scale Type

Set the scale type of Y-axis to Lin or Log. The default is Log.

- ◆ In Lin mode, Scale value cannot be changed. Display area for reference level of 0%. In process of using pay attention to the following points:
- ◆ In Log scale type, the Y-axis denotes the logarithmic coordinate; the value shown at the top of the grid is the reference level and each grid represents the scale value. The unit of Y-axis will automatically switch to the default unit (dBm) in Log scale type is changed from Lin to Log.
- ◆ In Lin scale type, the Y-axis denotes the liner coordinate; the values shown at the top of the grid and the bottom of the grid are the reference level and the scale setting function is invalid. The unit of Y-axis will automatically switch to the default unit (Volts) in Lin scale type when the scale type is charged from Log to Lin.

### 2.1.3.7 Ref Offset

Assign an offset to the reference level to compensate for gains or losses generated between the device under measurement and the analyzer.

The change of this value changes both the reference level readout and the amplitude readout of the marker; but does not impact the position of the curve on the screen.

Table 2-9 Ref Offset

Parameter	Explanation
Default	0dB
Range	-100dB ~ 100dB
Unit	dB
Knob Step	1dB
<b>Direction Key Step</b>	10dB



### 2.1.3.8 Correction

Correct the amplitude in order to compensate for the gain or loss from external devices such as Antenna and Cable. When using this function, you can view the correction data table and save or load the current correction data. When amplitude correction is turn on, both the trace and related measurement results will be corrected.

#### 1. RF Input

Set the input impedance for voltage-to-power conversions. The default is 50Ω. To measure a 75Ω device, you should use a 75Ω to 50Ω adapter to connect the analyzer with the system under test and then set the input impedance to 75Ω.

#### 2. Apply Correction

Enable or disable amplitude correction and the default are Off. The spectrum analyzer provides four correction factors and you can edit them separately.

#### 3. Edit Correction Factor

Table 2-10 Edit Correction table

Function	Explanation
Correction	Select the correction factor on or off.
Add Point	Add a point into correction table.
Point Num	Select a point to edit by point num.
Frequency	Edit the frequency value for the current selected point.
Amplitude	Edit the amplitude value for the current selected point.
Del Point	Delete the selected correction point.
Del All	Clear all data of the correction table.
Save/Load	Save or load correction data. You can save the current correction data into or load correction data from a .COR file.

### 2.1.4 Auto Tune

Search for signals automatically throughout the full frequency range; adjust the frequency and amplitude for optimum display effect of the signal to realize one-key signal search and auto setting of parameters.

- ◆ In the process of auto search, The “**Auto Tune**” is shown in the status bar on the screen until the search is finished.
- ◆ Some parameters such as the reference level, scale, input attenuation and maximum mixing level may be changed during the auto search.

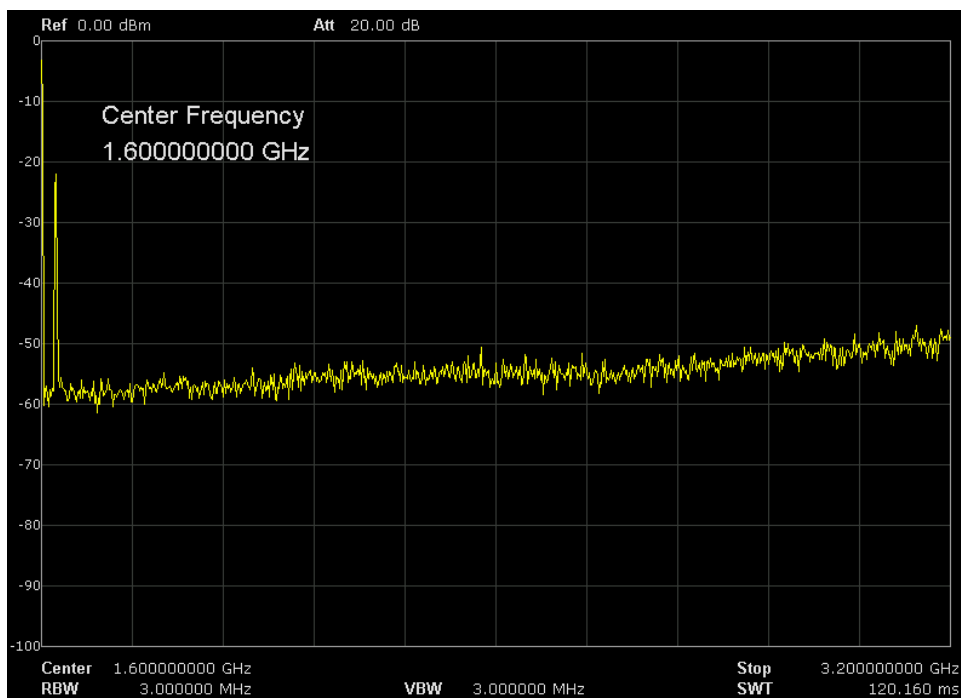

Figure 2-3 before Auto Tune

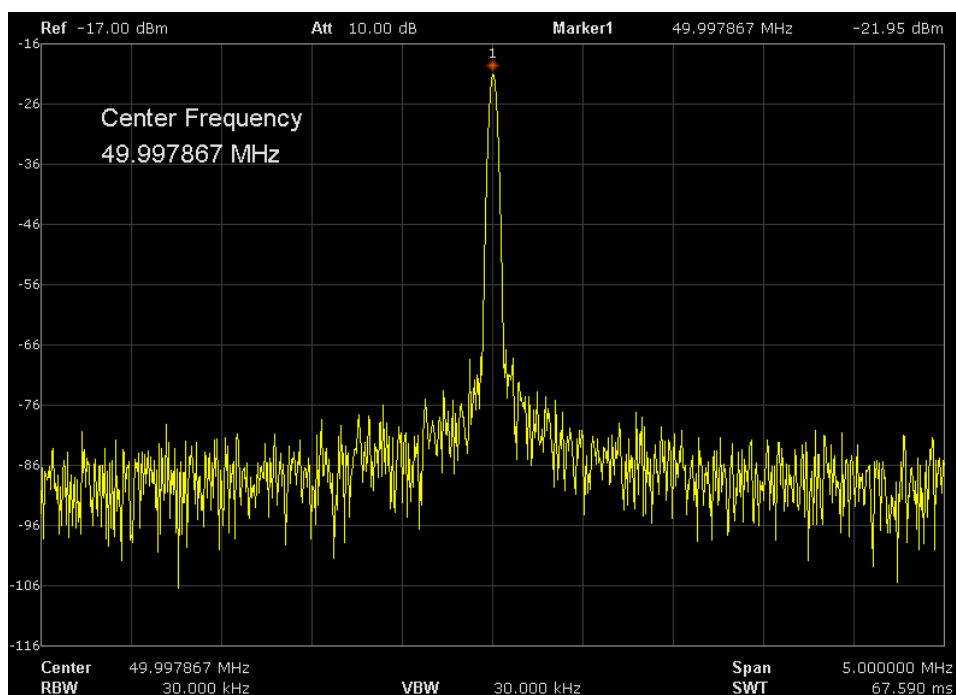

Figure 2-4 after Auto Tune

## 2.2 Sweep and Functions

### 2.2.1 BW

Set the RBW (Resolution Bandwidth), VBW (Video Bandwidth), average type parameters of the analyzer and filter shape.

#### 2.2.1.1 Resolution Bandwidth

Set the resolution bandwidth in order to distinguish between signals which are close in frequency.

- ◆ Reducing RBW will increase the frequency resolution, but will increase the sweep time (Sweep Time is affected by a combination of RBW and VBW when it is in Auto mode).
- ◆ RBW varies with the span (non-zero span) in Auto RBW mode.

Table 2-11 RBW

Parameter	Explanation
Default	1MHz
Range	10Hz ~ 1MHz
Unit	MHz, kHz, Hz
Knob Step	in 1, 3, 10 sequence
Direction Key Step	in 1, 3, 10 sequence
Relation	Span, RBW, VBW, Sweep Time

#### 2.2.1.2 Video Bandwidth

Set the desired video bandwidth in order to filter out the noise outside the video band.

- ◆ Reducing the VBW will smooth the spectrum line to highlight small signals from noise, but will increase the sweep time (Sweep Time is affected by a combination of RBW and VBW when it is in Auto mode).
- ◆ VBW varies with RBW when it is set to Auto. While in Manual mode, VBW is not affected by RBW.

Table 2-12 VBW

Parameter	Explanation
Default	1MHz
Range	1Hz ~ 3MHz
Unit	MHz, kHz, Hz
Knob Step	in 1, 3, 10 sequence
Direction Key Step	in 1, 3, 10 sequence
Relation	RBW, V/R Ratio, Sweep Time

### 2.2.1.3 V/R Ratio

Set the ratio of VBW to RBW. This value is different while measuring different kinds of signals:

- ◆ Sine signal: use 1 to 3 (for faster sweeps)
- ◆ Pulse signal: use 10 (to reduce the influence on the amplitude of transient signals)
- ◆ Noise signal: generally use 0.1 (to obtain the average of noises)

Table 2-13 V/R Ratio

Parameter	Explanation
Default	1
Range	0.001 ~ 1000
Unit	N/A
Knob Step	in 1, 3, 10 sequence
Direction Key Step	in 1, 3, 10 sequence
Relation	RBW,VBW

### 2.2.1.4 Average Type

Choose one of the following averaging types: log power (video), power (RMS), or voltage averaging. When trace average is on, the average type is shown on the left side of the display.

#### 1. Log Power

Select the logarithmic (decibel) scale for all filtering and averaging processes. This scale is "Video" because it is the most common display and analysis scale for the video signal within a spectrum analyzer. This scale is excellent for finding CW signals near noise.

#### 2. Power Average

In this average type, all filtering and averaging processes work on the power (the square of the magnitude) of the signal, instead of its log or envelope voltage. This scale is best for measuring the true time power of complex signals.

#### 3. Voltage Average

In this Average type, all filtering and averaging processes work on the voltage of the envelope of the signal. This scale is good for observing rise and fall behavior of AM or pulse-modulated signals such as radar and TDMA transmitters.

### 2.2.1.5 Filter

Set the RBW filter type. The analyzer supports two kinds of RBW filters: "Gauss" (-3 dB bandwidth) and "EMI" (-6 dB bandwidth).

When "EMI" is selected, resolution bandwidth can be 200 Hz, 9 kHz or 120 kHz only.

"Quasi-Peak" detector is available only in "EMI" filter.

## 2.2.2 Trace

The sweep signal is displayed as a trace on the screen.

### 2.2.2.1 Select Trace

Spectrum Analyzer allows for up to four traces to be displayed at the same time. Each trace has its own color (Trace 1 - Yellow, Trace 2 - Purple, Trace 3 - Light blue and Trace 4 - Green). All traces can be set parameter independently.

As a default, spectrum analyzer will choose Trace A and set the type of the trace as Clear Write

### 2.2.2.2 Trace Type

Set the type of the current trace or disable it.

The system calculates the sampled data using a specific operation method according to the trace type selected and displays the result. Trace types include Clear Write, Max Hold, Min Hold, View, Average and Bank.

The corresponding icon of the trace type will be displayed in the status bar at the left of the screen. Take Trace 1,2,3,4 as an example and the icons are as shown in the figure below.

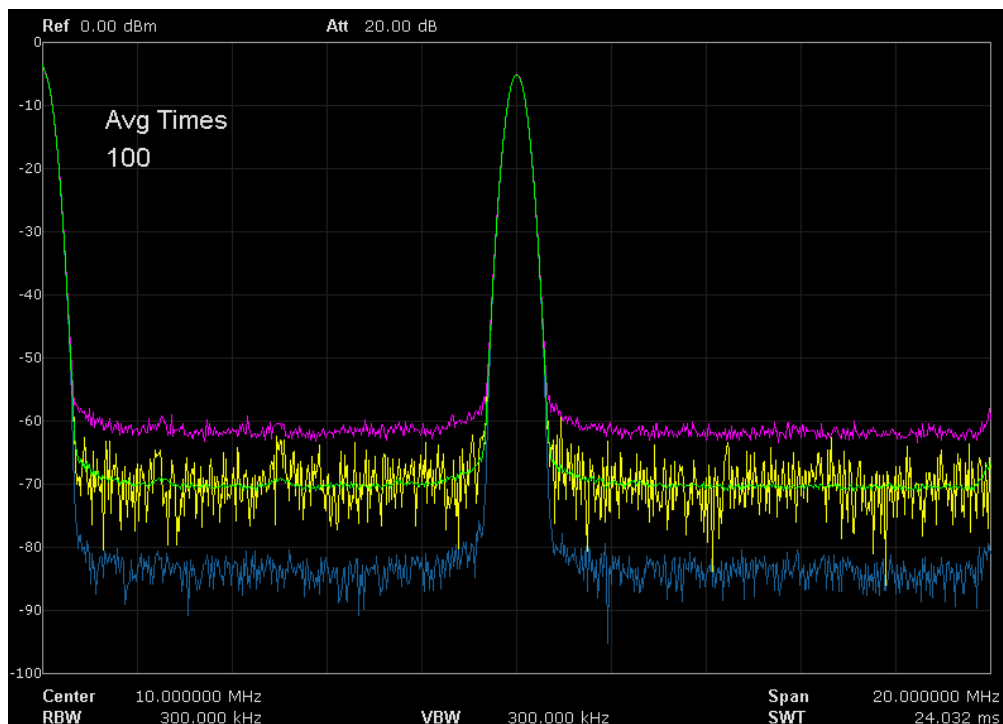

Figure 2-5 Trace Type

#### 1. Clear Write

Erases any data previously stored in the selected trace, and display the data sampled in real-time of each point on the trace.

**2. Max Hold**

Retains the maximum level for each trace point of the selected trace. Updates the data if a new maximum level is detected in successive sweeps.

**3. Min Hold**

Display the minimum from multiple sweeps for each point of the trace and update the data if a new minimum is generated in successive sweeps.

**4. View**

Holds and displays the amplitude data of the selected trace. The trace data is not updated as the analyzer sweeps.

**5. Bank**

Disable the trace display and all measurements of this trace.

**2.2.2.3 Average Times**

Set the number of averages of the selected trace. More averages can reduce the noise and the influence of other random signals; thus highlighting the stable signal characteristics. The larger the number of averages is, the smoother the trace will be.

Table 2-14 Average Times

Parameter	Explanation
Default	100
Range	1 ~ 999
Unit	N/A
Knob Step	1
Direction Key Step	5

**2.2.2.4 Math**

Set the computational method of the math trace.

**2.2.2.5 Variable X, Y**

Variable X, Y can choose trace A, B, C.

**2.2.2.6 Output Z**

The result Z will show on screen in trace A, B, C as you choose.

### 2.2.2.7 Calculation Type

Spectrum Analyzer provides the calculation types as shown below:

Power : X-Y+Offset

Power : X+Y+Offset

Log : X+Offset

Log : X-Y+Ref

### 2.2.3 Detect

The analyzer displays the sweep signal on the screen in the form of trace. For each trace point, the analyzer always captures all the data within a specific time interval and processes (Peak, Average, etc.) the capture data using the detector currently selected, then display the processed data (one point) on the screen.

- ◆ Select an appropriate detector type according to the actual application in order to ensure the accuracy of the measurement.
- ◆ The available types are **Pos Peak**, **Neg Peak**, **Sample**, **Normal**, **Average** and **Quasi Peak**. The default is **Pos peak**.

#### 1. Positive Peak

For each trace point, Positive Peak detector displays the maximum value of data sampled within the corresponding time interval.

#### 2. Negative Peak

For each trace point, Negative Peak detector displays the minimum value of data sampled within the corresponding time interval.

#### 3. Sample

For each trace point, Sample detector displays the transient level corresponding to the central time point of the corresponding time interval. This detector type is applicable to noise or noise-like signal.

#### 4. Normal

Normal detector (also called rosenfell detector) displays the maximum value and the minimum value of the sample data segment in turn; namely for an odd-numbered data point, the maximum value is displayed; for an even-numbered data point, the minimum value is displayed. In this way, the amplitude variation range of the signal is clearly shown.

#### 5. Average

For each trace point, Average detector displays the average value of data sampled within the corresponding time interval.

#### 6. Quasi Peak

Quasi-Peak detector, which is a weighted form of peak detector, is used for EMC pulse testing

ruled by CISPR. For single frequency point, the detector detects the peaks within QPD dwell time. The peaks detected are weighted using circuit with specified charge and discharge structures as well as the display time constant specified in the CISPR 16 standards. The measurement time for QPD is far longer than Peak Detector.

## 2.2.4 Sweep

Set parameters about the Sweep functions, including sweep time, sweep rule, sweep mode, number of sweep, etc.

### 2.2.4.1 Sweep Time

Set the time needed for the spectrum analyzer to finish a sweep within the span range. The sweep time can be set in “Auto” or “Manual” mode and the default is “Auto”.

- ◆ In non-zero span, the analyzer selects the shortest sweep time on the basis of the current RBW and VBW settings if Auto is selected.
- ◆ Decreasing the sweep time would speed the measurement. However, an error may be caused if the specified sweep time is less than the minimum sweep time in Auto coupling; at this point, “UNCAL” is shown in the status bar on the screen

Table 2-15 Sweep Time

Parameter	Explanation
Default	N/A
Range	900 us ~ 3 ks (Quasi Peak: 900 us ~ 30 ks)
Unit	ks, s, ms, us
Knob Step	Sweep time/100, min =1 ms
Direction Key Step	in 1,3 sequence

### 2.2.4.2 Sweep Rule

The analyzer provides two sweep time rules to meet the different sweep time requirements:

Speed: Activates the default fast sweep time rule.

Accuracy: Activates the normal sweep time rule to ensure the measurement accuracy. Speed sweep time rule provides a fast measurement function that decreases the sweep time. Using Fast Sweep will decrease the measurement accuracy.

### 2.2.4.3 Sweep

Set sweep mode in single or continuous, the default is continuous. The corresponding icon of the sweep will be displayed in the status bar at the left of the screen.

#### 1. Single



Set the sweep mode to “**Single**”. The number on the parameter icon denotes the current sweep number.

## 2. Numbers

Set the number of sweeps for a single sweep. In single sweep mode, the system executes the specified number of sweeps and the number shown on the icon in the status bar at the left of the screen varies with the process of the sweep.

## 3. Continue

Set the sweep mode to “Continue”. The character Cont on the parameter icon denotes the analyzer is sweeping continuously.

- ◆ If the instrument is in single sweep mode and no measurement function is enabled, press this key and the system will enter continuous sweep mode and sweep continuously if the trigger conditions are satisfied.
- ◆ If the instrument is in single sweep mode and a measurement function is on, press this key and the system will enter continuous sweep mode and measure continuously if the trigger conditions are satisfied.
- ◆ In continuous sweep mode, the system will send a trigger initialization signal automatically and enter the trigger condition judgment directly after each sweep.

Table 2-16 Sweep Times

Parameter	Explanation
Default	1
Range	1 ~ 9999
Unit	N/A
Knob Step	1
Direction Key Step	1

### 2.2.4.4 Sweep Mode

Sweep mode includes auto, sweep and FFT.

#### 1. Auto

When the sweep mode is auto, the analyzer selects the sweep mode automatically between Sweep and FFT Mode in the shortest time.

#### 2. Sweep

Work in point-by-point scanning. The Sweep mode is only available when RBW is in 30 Hz – 1 MHz

#### 3. FFT

Work in FFT scanning. The FFT mode is only available when RBW is in 1 Hz - 30 kHz.

When TG is on, the sweep mode is forced to Sweep.

### 2.2.4.5 QPD Dwell Time

Dwell time is the measurement time at a single frequency. QPD detector gets its weighted envelope response during dwell time. The longer dwell time is, the more sufficiently QPD detector responses to a single frequency, the more accuracy the QPD detector envelope is.

Table 2-17 QPD Dwell Times

Parameter	Explanation
Default	50 ms
Range	0 s ~ 10 s
Unit	ks, s, ms, us
Knob Step	N/A
Direction Key Step	N/A

### 2.2.5 Trigger

The trigger type can be Free Run, Video or External.

#### 1. Free Run

The trigger conditions are satisfied at any time and the analyzer generates trigger signals continuously.

#### 2. Video Trigger

A trigger signal will be generated when the system detects a video signal of which the voltage exceeds the specified video trigger level.

Set the trigger level in video trigger. At this point, the trigger level line (Trig Line) and value are displayed on the screen.

Table 2-18 Trigger Setup

Parameter	Explanation
Default	0 dBm
Range	-300 dBm ~ 50 dBm
Unit	dBm
Knob Step	1 dB
Direction Key Step	10 dB

#### 3. External

In this mode, an external signal (TTL signal) is input from the [TRIGGER IN] connector at the rear panel and trigger signals are generated when this signal fulfills the specified trigger edge condition.

Set the trigger edge in external trigger to the rising (Pos) or falling (Neg) edge of the pulse.

## 2.2.6 Limit

The analyzer supports Pass/Fail test function. In this function, the measured curve is compared with the pre-edited curve. If the related rules are met, the result is “**Pass**”; or else is “**Fail**”.

### 2.2.6.1 Limit1

Select enable or disable limit1.

### 2.2.6.2 Limit1 Edit

Edit the properties of the limit1 lines.

Table 2-19 Limit1 Edit Menu

Function	Explanation
Type	Select the desired limit line (upper or lower) for editing
Mode	Select the line or point for editing. Set the number of the point to be edited if you selected the point type. The range from 1 to 100
Add point	Add a new point for editing.
X-axis	Edit the X-axis value (frequency or time) of the current point. If the X-axis unit is frequency and the Ref Freq is enabled, edit the frequency difference between the frequency of the current point and the center frequency.
Amplitude	Edit the amplitude of the current point or line. If the Ref AMPT is enabled, edit the amplitude difference between the amplitude of the current point and the reference level.
Del Point	Delete the point you are editing.
Del All	Delete all point.
Save/Recall	Save or load the limit file.

### 2.2.6.3 Limit2

Select enable or disable limit2.

### 2.2.6.4 Limit2 Edit

Edit the properties of the limit2 lines.

Table 2-20 Limit2 Edit Menu

Function	Explanation
Type	Select the desired limit line (upper or lower) for editing
Mode	Select the line or point for editing. Set the number of the point to be edited if you

	selected the point type. The range from 1 to 100
Add point	Add a new point for editing.
X-axis	Edit the X-axis value (frequency or time) of the current point. If the X-axis unit is frequency and the Ref Freq is enabled, edit the frequency difference between the frequency of the current point and the center frequency.
Amplitude	Edit the amplitude of the current point or line. If the Ref AMPT is enabled, edit the amplitude difference between the amplitude of the current point and the reference level.
Del Point	Delete the point you are editing.
Del All	Delete all point.
Save/Recall	Save or load the limit file.

### 2.2.6.5 Test

Enable or disable the limit test function.

### 2.2.6.6 Setup

#### 1. Fail to stop

Select whether the instrument will continue or stop operation when a failure occurs.

#### 2. Buzzer

Turn on or off the buzzer. When the buzzer is on, it beeps when a failure occurs.

#### 3. X Axis

Set the X-axis unit to frequency or time unit.

Note that all the points of the current limit line will be deleted when the X-axis unit changes.

## 2.2.7 TG (Tracking Generator)

Set the parameters related to the tracking generator.

### 2.2.7.1 TG

When the TG is enabled, a signal with the same frequency of the current sweep signal will be output from the [TG SOURCE] connector at the front panel. The power of the signal could be set through the menu.

### 2.2.7.2 TG Level

Set the output power of the signal of the tracking generator.

Table 2-21 TG Level

Parameter	Explanation
Default	0 dB
Range	-20 dBm ~ 0 dBm
Unit	dBm
Knob Step	1 dB
Direction Key Step	10 dB

### 2.2.7.3 TG Level Offset

Assign a certain offset to the output power of the TG when gains or losses occur between the TG output and external device in order to display the actual power value.

- ◆ This parameter only changes the readout of the TG output power, rather than the actual value.
- ◆ The offset could be either a positive (gain in the external output) or a negative (loss in the external output).

Table 2-22 TG Level Offset

Parameter	Explanation
Default	0 dB
Range	-200 dB ~ 200 dB
Unit	dB
Knob Step	1 dB
Direction Key Step	10 dB

### 2.2.7.4 Normalize

Normalization can eliminate the error of TG Level. Before using this function, connect the **[TG SOURCE]** output terminal of the TG with the **[RF INPUT]** input terminal of the analyzer.

When enabled, the reference trace will be stored automatically after the current sweep finishes if no reference trace is stored before. During the reference trace storage, the corresponding prompt message is displayed.

When normalization is enabled, the corresponding value of the reference trace will be subtracted from the trace data after every sweep.

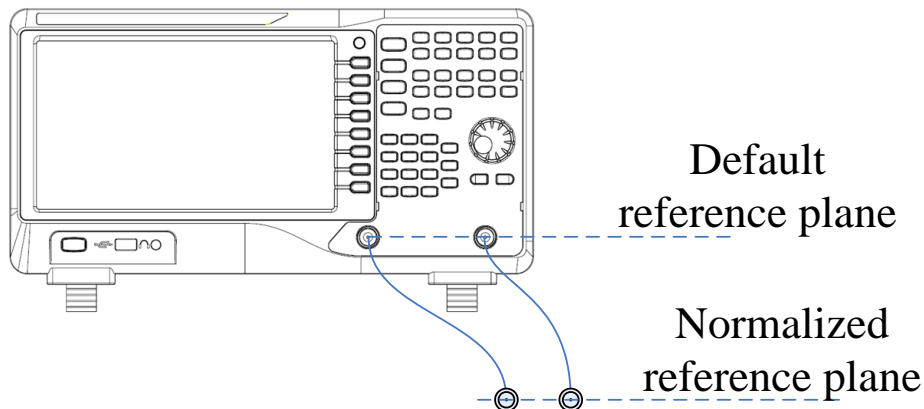

Figure 2-6 Normalization

### 2.2.7.5 Norm Ref Level

Adjust the vertical position of the trace on the screen by adjusting the reference level when normalization is enabled.

Different from the **Ref Level** function in the **AMPT** menu, this parameter has no influence on the reference level of the analyzer.

Table 2-23 Reference level under normalization

Parameter	Explanation
Default	0 dB
Range	-200 dB ~ 200 dB
Unit	dB
Knob Step	1 dB
Direction Key Step	10 dB

### 2.2.7.6 Norm Ref Pos

Adjust the vertical position of the normalization reference level on the screen by adjusting the reference position when normalization is enabled.

The function of this menu is similar to that of **Norm Ref Level**. When it is set to 0%, the normalization reference level is displayed at the bottom of the screen grid and at the top when it is set to 100%.

Table 2-24 TG reference position under normalization

Parameter	Explanation
Default	100%
Range	0 ~ 100%
Unit	100%
Knob Step	1%

Direction Key Step	10%
--------------------	-----

### 2.2.7.7 Ref Trace

Set whether to display the reference trace or not. If “View” is selected, the reference trace saved (Trace D) will be shown in “View” type.

**Note:** When normalization is enabled, the unit of Y-axis is “dB” and will not be influenced by the definition in **AMPT->Units**. At this point, “(dB)” is displayed under the Y-axis scale in the user interface.

## 2.2.8 Demod

Press **Demod** at the front panel to enter the demodulation setting menu. Both AM and FM demodulations are available in this device.

### 2.2.8.1 Demod (AM/FM)

Set the demodulation type to AM or FM; or disable the demodulation function. The default is off.

- ◆ The system will enable a marker automatically, place it at the center frequency and perform AM (or FM) demodulation on this frequency point after you enable AM (or FM) demodulation.
- ◆ Analyzer provides earphone jack and the demodulated signal can be output in audio frequency (AF) mode through the earphone. The frequency and intensity of AF denotes the frequency and amplitude of the signal respectively.

### 2.2.8.2 Earphone

Set the status of the earphone. When it is on, the demodulated signal can be heard through the earphone during the demodulation. By default, it is off.

### 2.2.8.3 Volume

Set the volume of the earphone.

Table 2-25 Volume

Parameter	Explanation
Default	6
Range	0 ~ 10
Unit	N/A
Knob Step	1
Direction Key Step	1

#### 2.2.8.4 Demod Time

Set the time for the analyzer to complete a signal demodulation after each sweep. If **Earphone** is set to "On", you will hear the demodulated signal through the earphone during the demodulation. A longer demod dwell time would be better to demodulate audio signal.

Table 2-26 Demod time

Parameter	Explanation
Default	5 s
Range	5 ms ~ 1000 s
Unit	ks, s, ms
Knob Step	0 ms ~ 100 ms, step=1 ms; 100 ms ~ 1 s, step =10 ms; 1 s ~ 10 s, step =100 ms; 10 s ~ 100 s, step =1 s; 100 s ~ 1000 s, step =10 s
Direction Key Step	1-2-5 step



## 2.3 Marker

### 2.3.1 Marker

The marker appears as a rhombic sign (as shown below) for identifying the point on the trace. You can easily read the amplitude, frequency and sweep time of the marked point on the trace.

- ◆ The analyzer allows for up to four pairs of markers to be displayed at one time, but only one pair or a single marker is active every time.
- ◆ You can use the numeric keys, knob or direction keys to modify the desired frequency or time as well as view the readouts of different points on the trace.

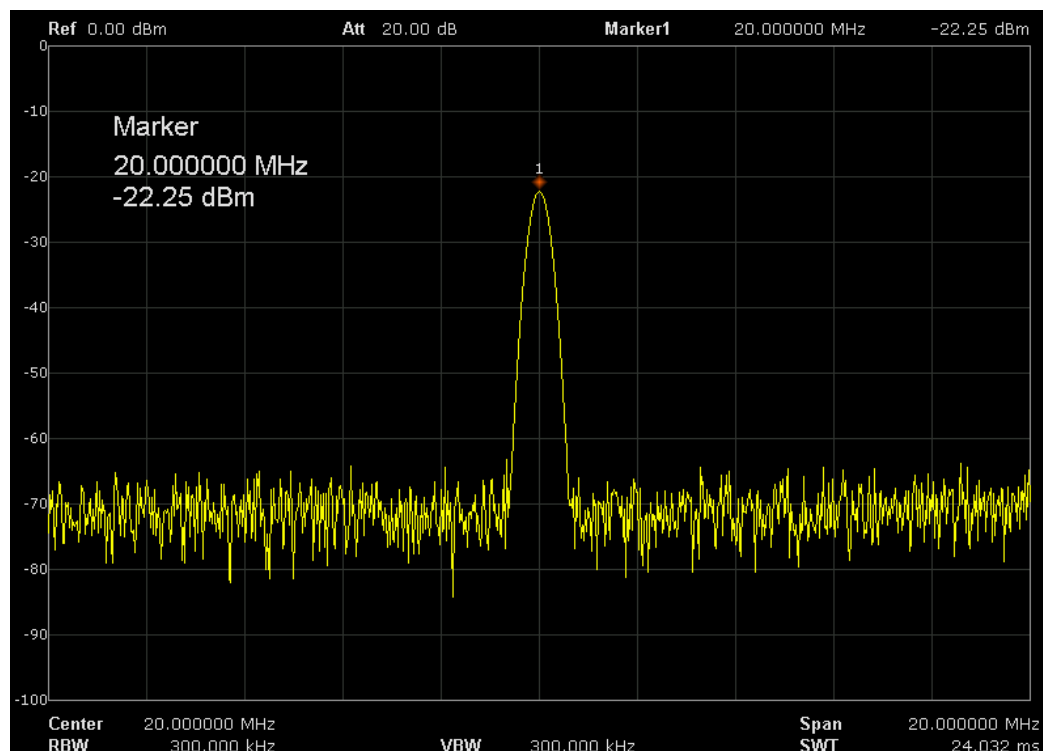

Figure 2-7 Marker

#### 2.3.1.1 Select Marker

Select one of the four markers and the default is Marker1.

When a marker is selected, you can set its type, trace to be marked, readout type and other related parameters. The enabled marker will appear on the trace selected through the **Select Trace** option and the readouts of this marker are also displayed in the active function area and at the upper right corner of the screen.

Table 2-27 Marker parameters

Parameter	Explanation
Default	Center Frequency
Range	0 ~ Full Span
Unit	Readout = Frequency , units available are GHz, MHz, kHz, Hz Readout = Time, units available are s, ms, us, ns, ps
Knob Step	Readout = Frequency (or Period), Step = Span/(Sweep Points - 1)
Direction Key Step	Readout = Frequency (or Period), Step = Span/10

### 2.3.1.2 Select Trace

Select the trace to be marked by the current marker from A, B, C, D.

### 2.3.1.3 Normal

One of the marker types. It is used to measure the X (Frequency or Time) and Y (Amplitude) values of a certain point on the trace. When selected, a marker with the number of the current marker (such as “1”) appears on the trace.

- ◆ If no active marker exists currently, a marker will be enabled automatically at the center frequency of the current trace.
- ◆ You can use the numeric keys, knob or direction keys to move the marker. The readouts of the marker will be displayed at the upper right corner of the screen.
- ◆ The readout resolution of the X-axis (frequency or time) is related to the span. For higher readout resolution, reduce the span.

### 2.3.1.4 Delta

One of the marker types. It is used to measure the delta values of X (Frequency or Time) and Y (Amplitude) between the reference point and a certain point on the trace. When selected, a pair of markers appears on the trace: Reference Marker (marked by a combination of the marker number and letter “r”, such as “1r”) and the Delta Marker (marked by the marker number, such as “1”).

- ◆ A reference marker will be activated at the position of the current marker if an active marker currently exists; or else both the reference marker and delta marker will be simultaneously activated at the center frequency.
- ◆ The location of the reference marker is always fixed (both on the X-axis and the Y-axis); while the Delta Marker is active. You can use the numeric keys, knob or direction keys to change the location of the Delta Marker.
- ◆ The frequency (or time) delta and amplitude delta between the two markers are displayed at the upper right corner of the screen.
- ◆ There are two methods for defining a point as the reference point:
  - a) Open a “Normal” marker and locate it onto a point. Then, switch the marker type to “Delta”; at this time, this point is the reference point. You can modify the location of the delta point to achieve delta measurement.

b) Open a “Delta” marker and locate it onto a point. Then, reselect the Delta menu to locate the reference marker onto this point. You can modify the location of the delta point to achieve delta measurement.

### The application of “Delta” marker

Measure the signal-noise ratio of single spectrum signal: Place the reference and delta Markers onto the signal and noise respectively, the amplitude in the measurement result is the signal-noise ratio.

#### 2.3.1.5 Delta Pair

One of the marker types. When selected, a pair of markers will appear on the trace: Reference Marker (marked by a combination of the marker number and letter “R”, such as “1R”) and the Delta Marker (marked by the marker number, such as “1”).

- ◆ You can use the numeric keys, knob or direction keys to set the locations of the reference marker (selecting “Ref”), the delta marker (selecting “Delta”), the span of marker pair(selecting “Span”) and the center of marker pair(selecting “Center”) respectively.
- ◆ This is different from the Delta type marker in that you can modify both the reference (selecting “Ref”) and delta (selecting “Delta”) points or modify both them at the same time (selecting “Span” or “Center”). Additionally, both the X and Y values of the reference marker are stable for “Delta” marker during the sweep; but the Y value of the reference marker updates along with the sweep for “Delta Pair” marker
- ◆ If “Span” is selected, setting the “Span Pair” will keep the center position of the two markers unchanged and move them towards the two sides (value increases) or the middle (value decreases).
- ◆ If “Center” is selected, setting the “Span Pair” will keep the relative distance between the two markers unchanged and move their center position left (value decreases) or right (value increases).

#### 2.3.1.6 Relative To

Relative to be used to measure the delta values of X (Frequency or Time) and Y (Amplitude) between two markers which mark on different traces.

#### 2.3.1.7 Off

Turn off the marker currently selected. The marker information displayed on the screen and functions based on the marker will also be turned off.

#### 2.3.1.8 Marker Table

Enable or disable the Marker Table.

Display all the markers enabled on the lower portion of the screen, including marker number, trace

number, marker readout type, X-axis readout and amplitude. Through this table you can view the measurement values of multiple points. The table allows for up to eight markers to be displayed at one time.

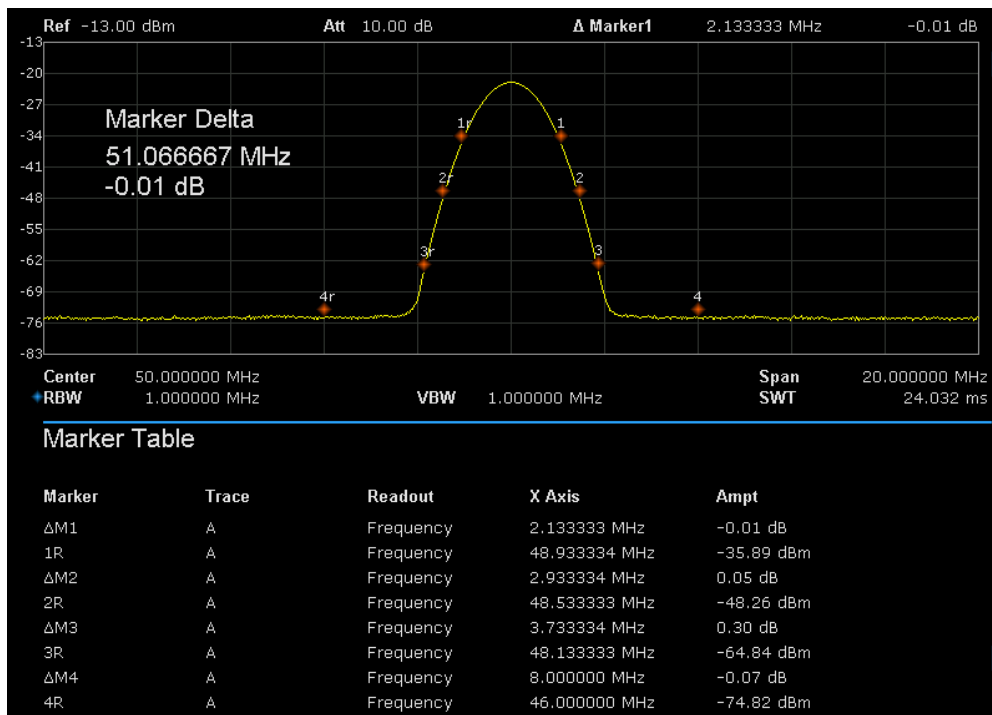

Figure 2-8 Marker table

### 2.3.2 Marker ->

#### 1. M->CF

Set the center frequency of the analyzer to the frequency of the current marker.

- ◆ If **Normal** marker is selected, the center frequency will be set to the frequency of the current marker.
- ◆ If **Delta** or **Delta Pair** marker is selected, the center frequency will be set to the frequency of the Delta Marker.
- ◆ The function is invalid in Zero span mode.

#### 2. M -> CF Step

Set the center frequency step of the analyzer to the frequency of the current marker.

- ◆ If **Normal** marker is selected, the center frequency step will be set to the frequency of the current marker.
- ◆ If **Delta** or **Delta Pair** marker is selected, the center frequency step will be set to the frequency of the Delta Marker.
- ◆ The function is invalid in Zero span mode.

#### 3. M -> Start Freq

---

Set the start frequency of the analyzer to the frequency of the current marker.

- ◆ If **Normal** marker is selected, the start frequency will be set to the frequency of the current marker.
- ◆ If **Delta** or **Delta Pair** marker is selected, the start frequency will be set to the frequency of the Delta Marker.
- ◆ The function is invalid in Zero span mode.

#### 4. **M -> Stop Freq**

Set the stop frequency of the analyzer to the frequency of the current marker.

- ◆ If **Normal** marker is selected, the stop frequency will be set to the frequency of the current marker.
- ◆ If **Delta** or **Delta Pair** marker is selected, the stop frequency will be set to the frequency of the Delta Marker.
- ◆ The function is invalid in Zero span mode.

#### 5. **M ->Ref Level**

Set the reference level of the analyzer to the amplitude of the current marker.

- ◆ If **Normal** marker is selected, the reference level will be set to the amplitude of the current marker.
- ◆ If **Delta** or **Delta Pair** marker is selected, the reference level will be set to the amplitude of the Delta Marker.

#### 6. **ΔM->Span**

Set the span of the analyzer to the frequency difference between the two markers in Delta, or **Delta Pair** marker type.

- ◆ If **Normal** marker is selected, this function is invalid.
- ◆ The function is invalid in Zero span mode.

#### 7. **ΔM->CF**

Set the center frequency of the analyzer to the frequency difference between the two markers in **Delta**, or **Delta Pair**, marker type.

- ◆ If **Normal** marker is selected, this function is invalid.
- ◆ The function is invalid in Zero span mode.

## 2.3.3 Marker Fn

Special marker functions including Noise Marker, N dB BW and Freq Counter.

### 2.3.3.1 Select Marker

Select one of the four markers (1, 2, 3, and 4) and the default is Marker1.

### 2.3.3.2 Noise Marker

Execute the Noise marker function for the selected marker and read the noise power spectral density.

- ◆ If the current marker is “Off” in the Marker menu, pressing **Noise Marker** will first set it to Normal type automatically; then measure the average noise level at the marked point and normalize this value to 1 Hz bandwidth. During this process, certain compensation is always made on the basis of the detection and trace types. The measurement will be more precise if RMS Avg or Sample detection type is used.
- ◆ This function can be used for measuring the C/N ratio.

### 2.3.3.3 N dB BW

Enable the N dB BW measurement or set the value of N dB. The N dB BW denotes the frequency difference between two points that are located on both sides of the current marker and with N dB fall (N<0) or rise (N>0) in amplitude as shown in the figure on the next page.

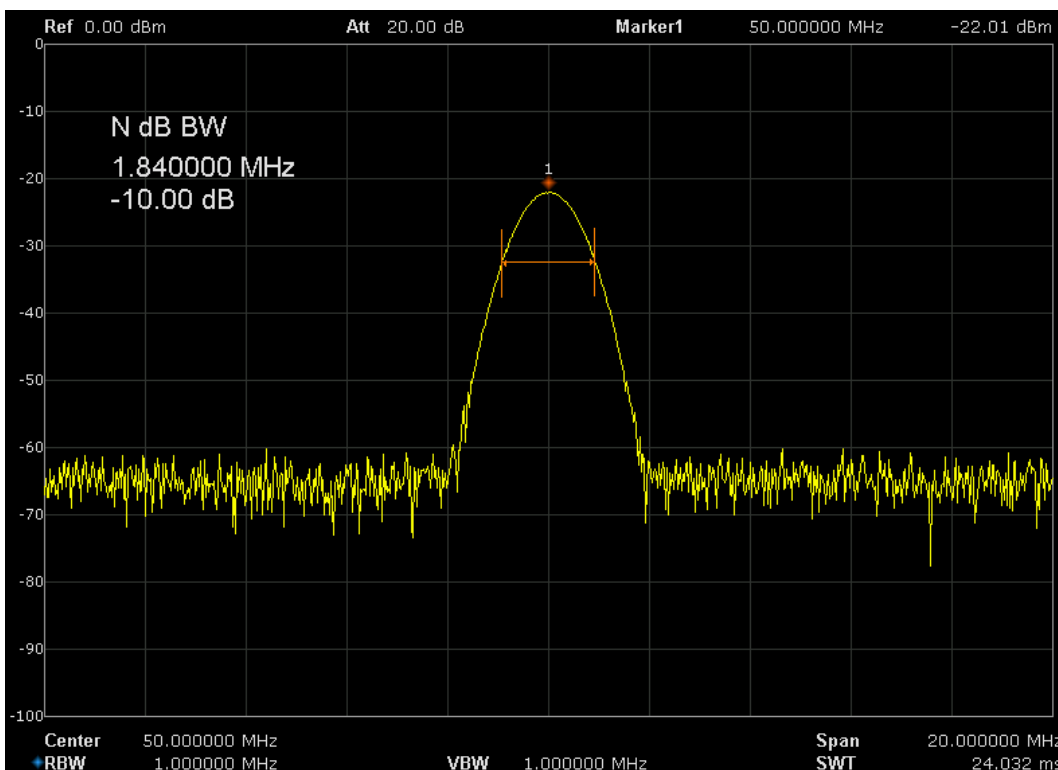

Figure 2-9 N dB BW

When the measurement starts, the analyzer will search for the two points which are located at both sides of the current point with N dB fall or rise in amplitude and display the frequency difference between the two points in the active function area. "----" would be displayed if the search fails.

Table 2-28 N dB Noise

Parameter	Explanation
-----------	-------------

Default	-3 dB
Range	-100 dB ~ 100 dB
Unit	dB
Knob Step	0.1 dB
Direction Key Step	1 dB

### 2.3.3.4 Freq Counter

Turn on or off the frequency counter. The frequency readout accuracy is up to 0.01 Hz.

- ◆ The function is invalid when selecting marker 2, 3, 4.
- ◆ If marker 1 is selected but no active, turning on the frequency counter will open marker 1 Normal marker automatically.
- ◆ The frequency counter measures the frequency near the center frequency in Zero span mode.

### 2.3.3.5 Off

Turn off the noise marker enabled, N dB BW measurement or Frequency Counter, but not the marker itself.

### 2.3.3.6 Read Out

Select a desired readout type of the X-axis for the marker and different markers can use different readout types. This setting will change the readout type and affect the marker readings in the active function area and at the upper right corner of the screen, but will not change the actual value.

#### 1. Frequency

In this type, Normal marker shows the absolute frequency; while Delta marker and Delta Pair marker show the frequency difference between the delta marker and reference marker. The default readout mode in non-zero span mode is “**Frequency**”.

Note: This type is invalid in Zero span mode.

#### 2. Period

In this type, Normal marker shows the reciprocal of frequency; while Delta marker and Delta Pair marker show the reciprocal of frequency difference. When the frequency difference is zero, the reciprocal is infinite and 100 Ts is displayed.

Note: This type is invalid in Zero span mode.

#### 3. Δ Time

In this type, Normal marker shows the time difference between the marker and the start of the sweep; while Delta marker and Delta Pair marker show the sweep time difference between the delta marker and reference marker.

The default readout mode in Zero span mode is  $\Delta$  Time.

### **2.3.4 Peak**

Open the peak search setting menu and execute peak search.

#### **2.3.4.1 Peak -> CF**

Execute peak search and set the center frequency of the analyzer to the frequency of the peak.

#### **2.3.4.2 Next Peak**

Search for and mark the peak whose amplitude is closest to that of the current peak and which meets the peak search condition.

#### **2.3.4.3 Next Left Peak**

Search for and mark the nearest peak which is located at the left side of the current peak and meets the peak search condition.

#### **2.3.4.4 Next Right Peak**

Search for and mark the nearest peak which is located at the right side of the current peak and meets the peak search condition.

#### **2.3.4.5 Peak Peak**

Execute peak search and minimum search at the same time and mark the results with delta pair markers. Wherein, the result of peak search is marked with the delta marker and the result of minimum search is marked with the reference marker.

#### **2.3.4.6 Count Peak**

Enable or disable continuous peak search and the default are Off. When enabled, the system will always execute a peak search automatically after each sweep in order to track the signal under measurement.

#### **2.3.4.7 Peak Table**

Open the peak table (in the lower window) which lists the peaks (with frequency and amplitude) that meet the peak search condition. Up to 16 peaks can be displayed in the table.



### 2.3.4.8 Search Comfit

Define the conditions of peak search for various peak searches. A real peak should meet the requirements of both the “**Peak Excursion**” and “**Peak Threshold**”.

#### 1. Peak Threshold

Assign a minimum for the peak amplitude. Peaks whose amplitudes are greater than the specified peak threshold are treated as real peaks.

Table 2-29 Peak Threshold

Parameter	Explanation
Default	-160 dBm
Range	-200 dBm ~ 200 dBm
Unit	dBm
Knob Step	1 dB
Direction Key Step	5 dB

#### 2. Peak Excursion

Set the excursion between the peak and the minimum amplitude on both sides of it. Peaks whose excursions are beyond the specified excursion are treated as real peaks.

Table 2-30 Peak Excursion

Parameter	Explanation
Default	15 dB
Range	0 dB ~ 200 dB
Unit	dB
Knob Step	1 dB
Direction Key Step	5 dB

#### 3. Peak Type

Set the peak search condition. The available options are Maximum and Minimum

## 2.4 Measurement

### 2.4.1 Meas

Provide measurement function, the screen will be divided into two parts, the above part is measure screen, displaying trace, the other part is used to display result of a measurement.

#### 2.4.1.1 Channel Power

Measure the power and power density within the specified channel bandwidth. When this function is enabled, the span and resolution bandwidth are automatically adjusted to smaller values. Select **Channel Power** and press **Meas Setup** to set the corresponding parameters.

#### 2.4.1.2 ACPR

Measure the powers of the main channel and adjacent channels as well as the power difference between the main channel and each of the adjacent channels. When this function is enabled, the span and resolution bandwidth of the analyzer are adjusted to smaller values automatically. Select **ACPR** and press **Meas Setup** to set the corresponding parameters.

#### 2.4.1.3 Occupied BW

Integrate the power within the whole span and calculate the bandwidth occupied by this power according to the specified power ratio. The OBW function also indicates the difference (namely "Transmit Freq Error") between the center frequency of the channel under measurement and the center frequency of the analyzer. Select **Occupied BW** and press **Meas Setup** to set the corresponding parameters.

#### 2.4.1.4 T-Power

The system enters zero span mode and calculates the power within the time domain. The types of powers available include Peak, Average and RMS. Select **T-Power** and press **Meas Setup** to set the corresponding parameters.

#### 2.4.1.5 TOI

Automatic measurement of IP3 (Third order Intercept Point), including the power of fundamental wave and the Third order in the power, and calculate the adjustable Intercept Point

### 2.4.1.6 Spectrum Monitor

Display the power of spectrum in color spectrum. Select **Spectrum Monitor** and press **Meas Setup** to set the corresponding parameters.

### 2.4.1.7 Meas Off

Turn off all the Meas function.

## 2.4.2 Meas setup

### 2.4.2.1 Channel Power

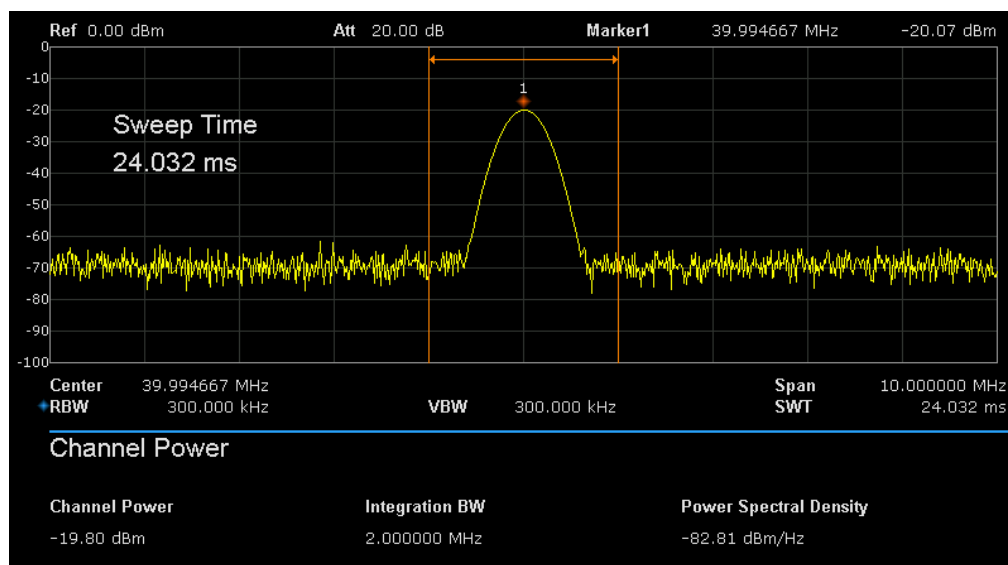

Figure 2-10 Channel Power

**Measurement Results:** channel power and power spectral density.

- ◆ Channel Power: power within the integration bandwidth.
- ◆ Power Spectral Density: power (in dBm/Hz) normalized to 1Hz within the integration bandwidth.

**Measurement Parameters:** Center Freq, integration bandwidth, Span, Span power.

#### 1. Center Freq

Sets the center frequency, this center frequency which is the same with the center frequency of the analyzer. Modifying this parameter will change the center frequency of the analyzer.

#### 2. Integration bandwidth

Set the frequency width of the channel to be tested and the power of the channel is the power

integral within this bandwidth. You can use the numeric keys, knob or direction keys to modify this parameter.

Table 2-31 Integration BW

Parameter	Explanation
Default	2 MHz
Range	100 Hz ~ Span
Unit	GHz, MHz, kHz, Hz
Knob Step	Integration BW/100, the minimum is 1 Hz
Direction Key Step	In 1-1.5-2-3-5-7.5 sequence

**3. Span**

Set the frequency range of the channel. This span which is the same with the span of the analyzer is the frequency range of the sweep. Modifying this parameter will change the span of the analyzer.

The channel power span is related to the integration bandwidth and the range available is from integration bandwidth to integration bandwidth×20.

Table 2-32 Channel Power Span for Chan Power Measurement

Parameter	Explanation
Default	3 MHz
Range	100 Hz ~ Span
Unit	GHz, MHz, kHz, Hz
Knob Step	Channel Power Span/100, the minimum is 1Hz
Direction Key Step	In 1-1.5-2-3-5-7.5 sequence

**4. Span Power**

Set the integrated bandwidth to the sweep span of display. The channel power and power spectral density display on the screen simultaneously.

## 2.4.2.2 ACPR

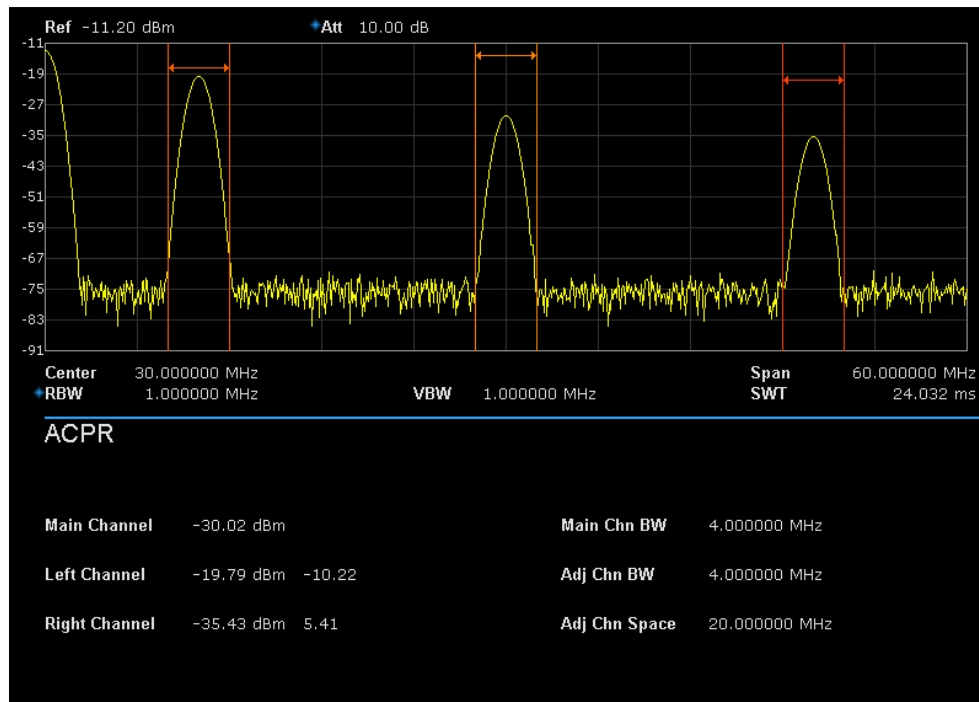

Figure 2-11 ACPR

Adjacent Channel Power Measurement: Main CH Power, Left channel power and Right channel power.

- ◆ Main CH Power: display the power within the bandwidth of the main power
- ◆ Left channel power : display the power of left channel and the power difference between the left channel and the main channel (in dBc)
- ◆ Right channel power: display the power of the right main channel and the power difference between the right channel and the main channel(in dBc)

**Measurement parameter:** center frequency, main channel bandwidth, adjacent channel bandwidth and channel spacing

### 1. Center Frequency

Sets the center frequency, this center frequency which is the same with the center frequency of the analyzer. Modifying this parameter will change the center frequency of the analyzer.

### 2. Main channel bandwidth

Set the bandwidth of the main channel and the power of the main channel is the power integral within this bandwidth. You can use the numeric keys, knob and direction keys to modify this parameter.

Table 2-33 Main channel bandwidth

Parameter	Explanation
Default	2 MHz
Range	100 Hz ~ Sweep Span
Unit	GHz, MHz, kHz, Hz
Knob Step	Integration BW /100, the minimum is 1 Hz
Direction Key Step	In 1-1.5-2-3-5-7.5 Sequence

### 3. Adjacent channel bandwidth

Set the frequency width of the adjacent channels.

The adjacent channel bandwidth is related to the main channel bandwidth and the range available is from main channel bandwidth/20 to main channel bandwidth×20.

Table 2-34 adjacent channel bandwidth

Parameter	Explanation
Default	2 MHz
Range	100 Hz ~ Sweep Span
Unit	GHz, MHz, kHz, Hz
Knob Step	Integration BW /100, the minimum is 1 Hz
Direction Key Step	In 1-1.5-2-3-5-7.5 Sequence

### 4. Adjacent Channel space

Set the difference between the center frequency of the main channel and the center frequency of the adjacent channels.

Adjusting this parameter will also adjust the distance between the upper/lower channel and the main channel.

Table 2-35 Adjacent channel space

Parameter	Explanation
Default	2 MHz
Range	33 Hz ~ full span
Unit	GHz, MHz, kHz, Hz
Knob Step	Integration BW /100, the minimum is 1 Hz
Direction Key Step	In 1-1.5-2-3-5-7.5 Sequence

### 2.4.2.3 OBW

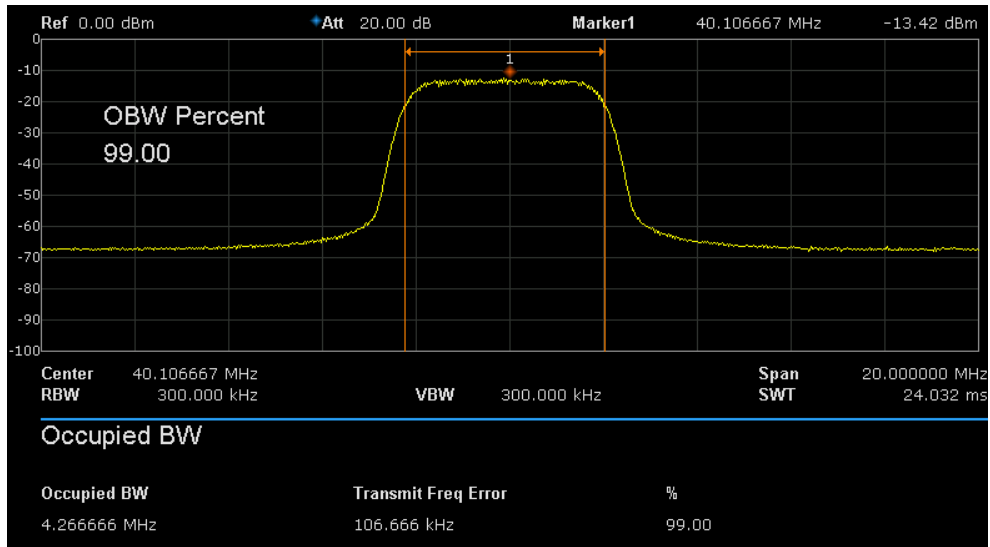

Figure 2-12 OBW

OBW measurement: occupied bandwidth and transmit frequency error.

- ◆ Occupied Bandwidth: integrate the power within the whole span and then calculate the bandwidth occupied by the power according to the specified power ratio.
- ◆ Transmit Frequency Error: difference between the center frequency of the channel and the center frequency of the analyzer.

### 2.4.2.4 T-Power

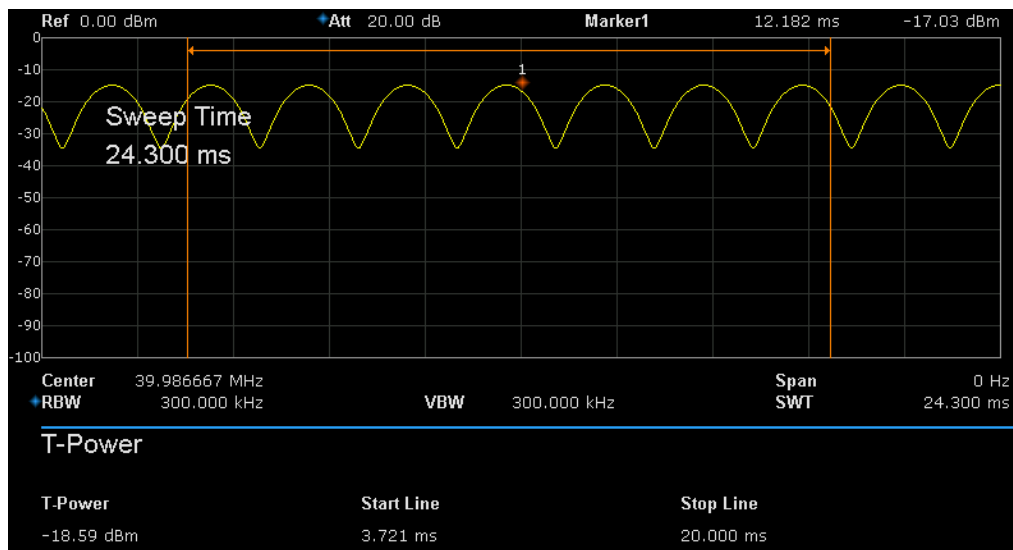

Figure 2-13 T-Power

T-Power: namely the power of the signal from the start line to the stop line.

**Measurement Parameter:** center frequency, start line, stop line.

### 1. Center Frequency

Sets the center frequency, this center frequency which is the same with the center frequency of the analyzer. Modifying this parameter will change the center frequency of the analyzer.

### 2. Start line

Set the left margin (in time unit) of T-Power measurement. The data calculated under this measurement is between the start line and stop line. You can use the numeric keys, knob or direction keys to modify this parameter.

Table 2-36 start line

Parameter	Explanation
Default	1ms
Range	0 s ~ stop line
Unit	ks, s, ms, us, ns
Knob Step	Sweep time/751
Direction Key Step	In 1-1.5-2-3-5-7.5 Sequence

### 3. Stop line

Set the right margin (in time unit) of T-Power measurement. The data calculated under this measurement is between the start line and stop line. You can use the numeric keys, knob or direction keys to modify this parameter.

Table 2-37 stop line

Parameter	Explanation
Default	24.032ms
Range	Start line ~ sweep time
Unit	ks, s, ms, us, ns
Knob Step	Sweep time /751
Direction Key Step	In 1-1.5-2-3-5-7.5 Sequence



### 2.4.2.5 TOI

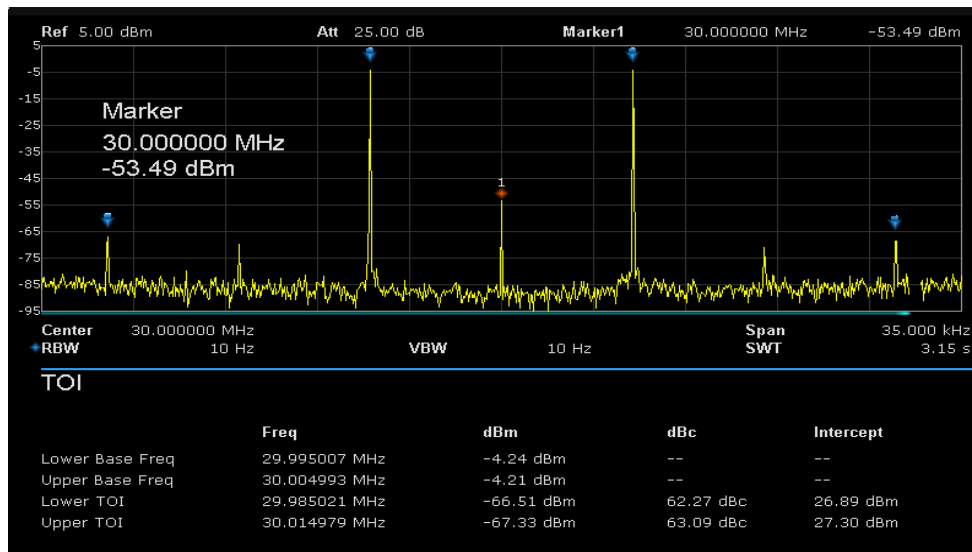

Figure 2-14 TOI

TOI is automatic measurement; do not need to set parameters.

### 2.4.2.6 Spectrum Monitor

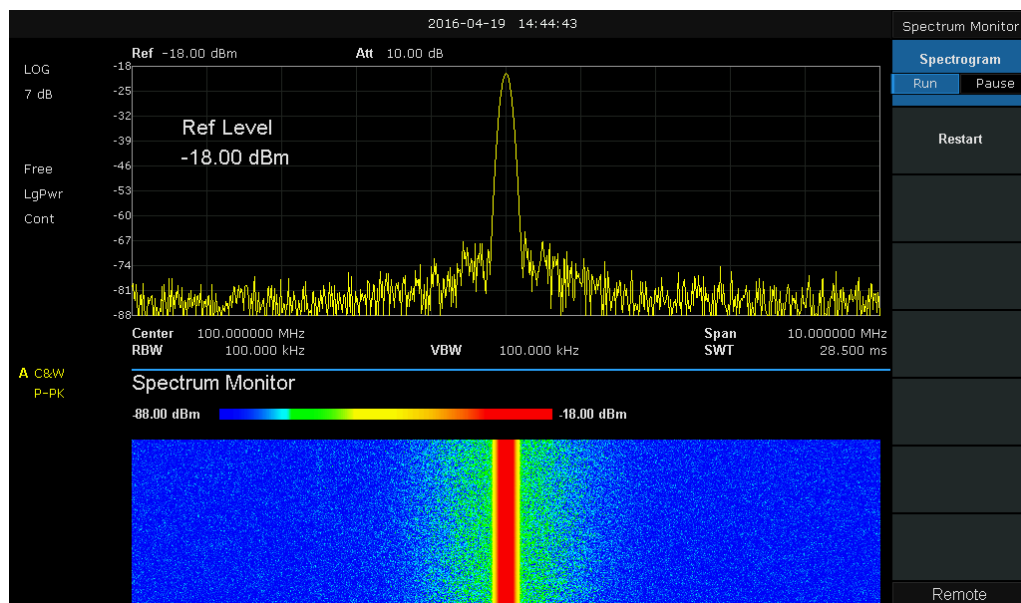

Figure 2-15 Spectrum Monitor

Display the power of spectrum in color spectrum.

**Spectrogram:** Sets the meas state of spectrum monitor.

## 2.5 System

### 2.5.1 System

Set the system parameters.

#### 2.5.1.1 Language

The analyzer supports multi-language menu, Chinese and English build-in help and popup messages.

Press this key to select the desired display language.

#### 2.5.1.2 Power On/Preset

##### 1. Power On

Set the power on setting to Default, Last or one of user.

- ◆ Def: Load the default settings, for more details please refer to Table 2-40.
- ◆ Last: When Last is selected, settings before the last power-off would be recalled automatically at power on.
- ◆ User: If power on set to user, the device will recall the specified configuration after power on.

##### 2. Preset

Set the preset type to Default, Last or one of User.

- ◆ Def : When press **Preset**, load the default settings, for more details please refer to Table 2-40.
- ◆ Last: When press **Preset**, load the last power-off settings.
- ◆ User : When press **Preset**, load the specified configuration type.

##### 3. User Config

Save the current instrument setting as user-defined setting into the internal non-volatile memory.

##### 4. Factory

When **factory** is selected, the device will recall the initial config.

##### 5. Reset & Clear

When **Reset & Clear** is selected, the device will recall the initial config and all user data and settings will be erased.

#### 2.5.1.3 Interface Config

The analyzer supports communications through LAN, USB and USB-GPIB as standard interface.

## 1. LAN

Config or reset related parameters of LAN. As default, the IP config is DHCP.

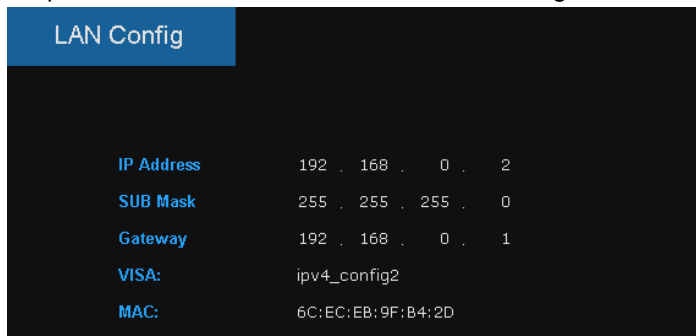

Figure 2-16 Static IP Config

## 2. GPIB

Config GPIB port number. The analyzer provides a USB-GPIB port on the front board.

### 2.5.1.4 Calibration

#### Auto Cal

When **Auto Cal** opens, the analyzer will process self-calibration regularly. Within half an hour after power-on, the device executes a self-calibration every 10 minutes.

### 2.5.1.5 System Info

#### 1. System Info

- ◆ Product Model, Serial and HOST ID
- ◆ Software Version and Hardware Version
- ◆ Option Information

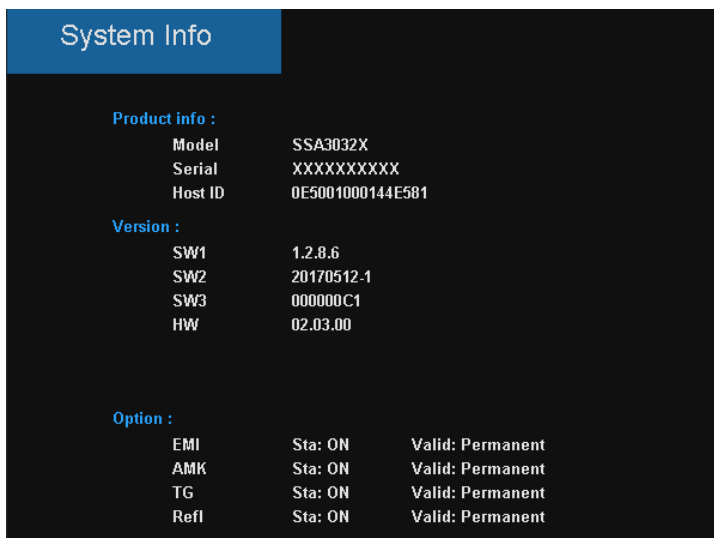

Figure 2-17 System Info

**2. Load Option**

Load license, enter license here to load options.

**3. Firmware Update**

Update firmware from .ADS file in storage. After firmware updated, the analyzer will be reboot.

**2.5.1.6 Data and Time**

Display the data and time On or Off. The system time is displayed in “ymd”, “mdy”, “dmy” format in user interface.

**2.5.1.7 Self Test**

**1. Screen Test**

Test whether the screen has a dot defect using five colors: White, Red, Green, Blue and Black. Press any key to switch the screen color and exit the test.

**2. Keyboard Test**

Enter the keyboard test interface. Press the function keys at the front panel one by one and observe whether the corresponding key is checked. If not, an error may have occurred in that key. To exit the test, press “<”four times.

**3. LCD Test**

If the keys at the front panel are transparent, when the key is pressed, the corresponding backlight will turn on when testing it.

**2.5.2 Display**

**1. Display Line**

Open or Close Display Line or move the location.

Table 2-38 Grid brightness

Parameter	Explanation
Default	0 dBm
Range	REF Level + REF Offset – 10*Scale/Div ~ REF Level + REF Offset
Knob Step	1 dB
Direction Key Step	10 B

**2. Grid brightness**

Control the display grid brightness.

Table 2-39 Grid brightness

Parameter	Explanation
Default	30%
Range	0 ~ 100%
Unit	None
Knob Step	1%
Direction Key Step	1%

### 3. Screen Text

Open or close the current parameter and its value in the wave area.

### 4. Screenshot

Select the screenshot type to normal and color inverse.

The color of trace is not inverted in inverse mode.

## 2.5.3 File

### 2.5.3.1 Browser

Browser type including “Dir” and “File”,

Dir: when selected, use the knob or direction keys to browser directory in system

File: when selected, use the knob or direction keys to switch among files or folders under the current directory.

### 2.5.3.2 Open/Load

Open the current folder or load current file

### 2.5.3.3 View Type

User can define the file type be browsed, included “All Type”, “STA”, “TRC”, “COR”, “CSV”, “LIM”, “PIC(JPG/BMP/PNG)”.

### 2.5.3.4 Save Type

User can define the file type be saved, included “STA”, “TRC”, “COR”, “CSV”, “LIM”, “JPG”, “BMP”, “PNG”.

### 2.5.3.5 Save

Save file in current directory, the file type is set in "**Save Type**".

An external U disk has the priority to be written in first.

#### 1. STA(Status)

STA files can be used to save and recall the instrument configuration. They are saved in binary format, which is designed to be used by the analyzer, not read by humans.

#### 2. TRC(Trace)

TRC files store the active (visible) trace data and scaling factors that were in place when the data was saved. They are saved in binary format, which is designed to be used by SSA3X instruments, not read by humans.

**NOTE:** When you first recall trace files, the instrument will adjust the display parameters (horizontal and vertical scaling, for example) to match the settings used during data collection. The trace data will not change, even if you adjust the parameters.

#### 3. COR(Correction)

COR files store the data used to mathematically adjust the displayed input signal based on external factors (Cable loss, Amplifier/Antenna gain, etc.). They are saved in ASCII format, which can be read by humans.

#### 4. CSV(Comma-Separated Variable)

CSV files store instrument configuration (scaling, units, etc..) and raw data (amplitude and frequency values) in ASCII format, commonly viewed in spreadsheet programs like Microsoft<sup>®</sup> Excel<sup>®</sup>. This file type can be read by humans.

#### 5. LIM(limit)

LIM files store the line or point data used to configure and display lines used for visual indication of a user-defined limit. This is a binary file intended for use with SSA3X instruments and is not readable by humans.

#### 6. BMP(Bitmap)/JPG(JPEG)/PNG

Picture files capture the display of the instrument (screenshot) as an image file. All of the details of the display are captured exactly. What you see on the display is in the file. These are readable using image programs.

### 2.5.3.6 Create Folder

Create a new folder in current directory.

### 2.5.3.7 Operate

**Open/Load:** Open the selected folder or directory, Load the selected file.

**Select All:** Select all the files in current directory

**Cut:** Cut the Selected file or folder, and delete the primary one after paste.

**Copy:** Copy the Selected file or folder for paste.

**Paste:** Paste the file cut or copied before into the current.

**Delete:** Delete selected file or directory.

**Rename** the selected file or folder.

## 2.6 Shortcut Key

### 2.6.1 Preset

Recall the preset setting and restore the analyzer to a specified status.

- ◆ Press **System** ->**Pwr On/Preset** ->**Preset** to select “Def”, “Last” or “User”.
- ◆ Press **Preset** to load the factory settings listed in the following table (except items marked with “\*\*”) or User-defined settings.

Table 2-40 Factory Settings

Parameter	Default
<b>Frequency</b>	
Center Freq	1.6 GHz
Start Freq	0 Hz
Stop Freq	3.2 GHz
Freq Step	Auto
<b>Span</b>	
Span	3.2 GHz
X Scale\	Linear
<b>Amplitude</b>	
Ref Level	0 dBm
Attenuator	Auto, 20 dB
Preamp	Off
Units	dBm
Scale/Div	10 dB
Scale Type	Log
Ref Offset	0 dBm
Corrections	Off
<b>BW</b>	
RBW	Auto, 1 MHz
VBW	Auto, 1 MHz
VBW/RBW	1
Avg Type	Log Pwr
Filter	Gauss
<b>Sweep</b>	
Sweep Time	Auto
Sweep Rule	Speed
Sweep	Continue
Sweep Mode	Auto
Numbers	1
<b>Trig</b>	



Trigger Type	Free Run
Video Trigger	0 dBm
External Trigger	Rising
<b>TG</b>	
TG	Off
TG Level	-20 dBm
TG Lvl Offset	0 dB
Normalize	Off
Norm Ref Lvl	0 dB
Norm Ref Pos	100%
Ref Trace	Blank
<b>Trace</b>	
Select Trace	A
Trace Type of Trace A	Clear Write
Avg Times	100
Variable X	A
Variable Y	B
Constant	0 dB
Output Z	C
Math Type	Off
<b>Detect</b>	
Select Trace	A
Detect Type of Trace A	Pos Peak
<b>Limit</b>	
Limit1	Off, Limit Upper, 0 dBm
Limit2	Off, Limit Lower, -100 dBm
Test	Stop
Fail to stop	Off
Buzzer	Off
X Axis	Freq
<b>Demod</b>	
Demod Mode	Close
Earphone	Off
Volume	6
Demod Time	5.00 s
<b>Marker</b>	
Select Marker	1
Select Trace	A
Marker Type	Normal
Delta Pair	Delta
Relative To	Off
Marker Table	Off
<b>Marker Fn</b>	

Select Marker	1
Marker Fn	Off
N dB BW	-3 dB
Read Out	Frequency
<b>Peak</b>	
Cont Peak	Off
Peak Table	Off
Peak Threshold	-160 dBm
Peak Excursion	15 dB
Peak Type	Max
<b>Mode</b>	
Mode	Spec Analyzer
<b>Measure</b>	
Meas Type	Off
<b>Measure Setup</b>	
<b>Channel Power</b>	
Center Freq	1.6 GHz
Integration BW	2 MHz
Span	3.2 GHz
<b>ACPR</b>	
Center Freq	1.6 GHz
Main Channel	1 MHz
Adjacent Chn	1 MHz
Adj Chn Space	3 MHz
<b>Occupied BW</b>	
Method	%
dBc	26
%	99
<b>T-Power</b>	
Center Freq	1.6 GHz
Start Line	0 s
Stop Line	20 ms
<b>System**</b>	
Language	English
Power On	Def
Preset	Def
IP Config	DPCH
Auto Cal	Close
Date & Time	On
Set Format	ymd
<b>Display**</b>	
Display Line	Off, 0 dBm
Grid Brightness	30%

---

Screen Text	On
Screenshot	Inverse

## 2.6.2 Couple

Set related parameters according to the coupling relationship.

Auto all: Set Related parameters automatically according to the coupling relationship.

### 1. RBW

RBW have couple relationship with span. Please refer to the introduction of the "**Resolution Bandwidth**".

### 2. VBW

VBW have coupling relationship with VBW. Please refer to the introduction of "**VBW**".

### 4. Attenuation

Input attenuation has coupling relationship with Ref Level, preamp. Please refer to introduction of the "**amplitude**".

### 5. Freq step

Freq step have coupling relationship with RBW at the zero span, when in none-zero mode, Freq step have coupling relationship with Span. please refer to the introduction of the "Freq Step".

### 6. Sweep time

Sweep time have coupling relationship with RBW, VBW and span. Please refer to the introduction of "**Sweep Time**".

## 2.6.3 Help

After press **Help**, press any key to show help information. Press **Help** second time to close help information

## 2.6.4 Save

Quick saving a file, according to "**File->Save Type**" settings.

Default file type is "PNG"

## Chapter 3 Remote Control

SSA3000X Series Spectrum Analyzer support LAN, USB Device, and GPIB--USB Host interfaces. By using these interfaces, in combination with programming languages and/or NI-VISA software, users can remotely control the analyzer based on SCPI (Standard Commands for Programmable Instruments) command set, and interoperate with other programmable instruments.

This chapter introduces how to build communication between the spectrum analyzer and a controller computer with these interfaces.

### 3.1 Remotely Operating the Analyzer

The analyzer provides both the USB and LAN connection which allows you to set up a remote operation environment with a controller computer. A controller computer could be a personal computer (PC) or a minicomputer. Some intelligent instruments also function as controllers.

#### 3.1.1 Connecting the Analyzer via the USB Device port

Refer to the following steps to finish the connection via USB-Device:

1. Install NI-VISA on your PC for USB-TMC driver.
2. Connect the analyzer USB Device port to a PC with a USB A-B cable.



3. Switch on the analyzer

The analyzer will be detected automatically as a new USB hardware.

#### 3.1.2 Connecting the Analyzer via the LAN port

Refer to the following steps to finish the connection via LAN:

1. Install NI-VISA on your PC for VXI driver. Or without NI-VISA, using socket or telnet in your PC's Operating System.
2. Connect the analyzer to PC or the local area network with a LAN cable



3. Switch on the analyzer
4. Press button on the front panel **System** → Interface → LAN to enter the LAN Config function menu.
5. Select the IP Config between Static and DHCP
  - ◆ DHCP: the DHCP server in the current network will assign the network parameters automatically (IP address, subnet mask, gate way) for the analyzer.
  - ◆ Static: you can set the IP address, subnet mask, gate way manually. Press Apply.

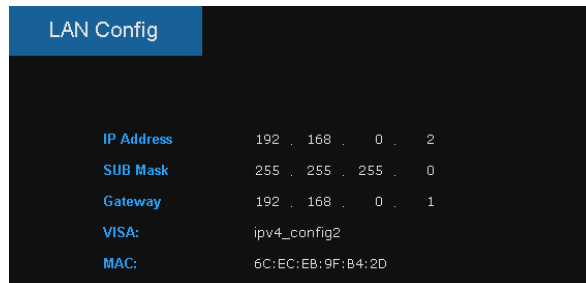

The analyzer will be detected automatically or manually as a new LAN point.

### 3.1.3 Connecting the Analyzer via the USB Host port

Refer to the following steps to finish the connection via USB:

1. Install NI-VISA on your PC for GPIB driver.
2. Connect the analyzer USB Host port to a PC's GPIB card port, with SIGLENT USB-GPIB adaptor.



3. Switch on the analyzer
4. Press button on the front panel **System** → Interface → GPIB to enter the GPIB number.

The analyzer will be detected automatically as a new GPIB point.

## 3.2 Build Communication

### 3.2.1 Build Communication Using VISA

NI-VISA includes a Run-Time Engine version and a Full version. The Run-Time Engine version provides NI device drivers such as USB-TMC, VXI, GPIB, etc. The full version includes the Run-Time Engine and a software tool named NI MAX that provides a user interface to control the device.

You can get NI-VISA full version from:

<http://www.ni.com/download/>.

After download you can follow the steps below to install it:

- a. Double click the visa\_full.exe, dialog shown as below:

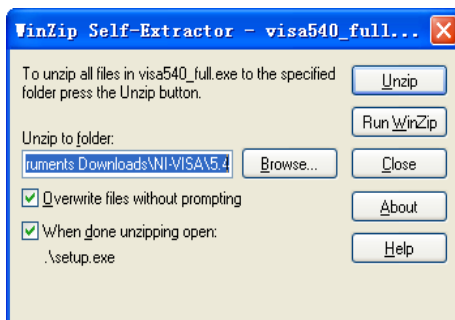

- b. Click Unzip, the installation process will automatically launch after unzipping files. If your computer needs to install .NET Framework 4, its setup process will auto start.



- c. The NI-VISA installing dialog is shown above. Click Next to start the installation process.

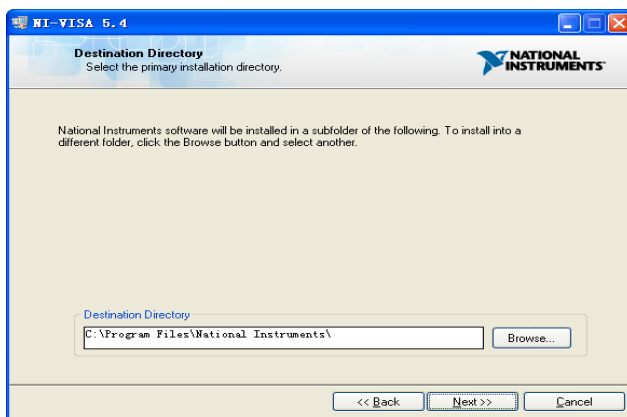

Set the install path, default path is “C:\Program Files\National Instruments\”, you can change it. Click Next, dialog shown as above.

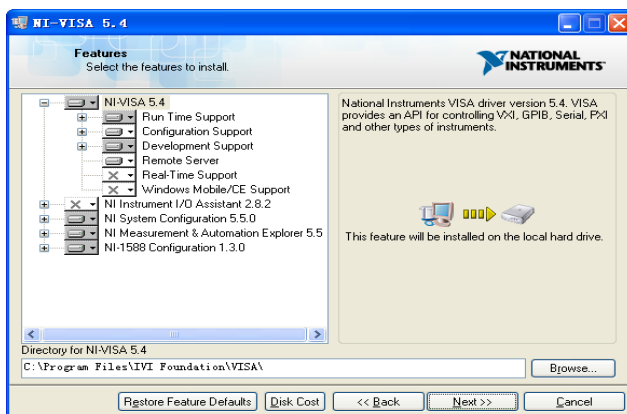

d. Click Next twice, in the License Agreement dialog, select the “ I accept the above 2 License Agreement(s).” ,and click Next, dialog shown as below:

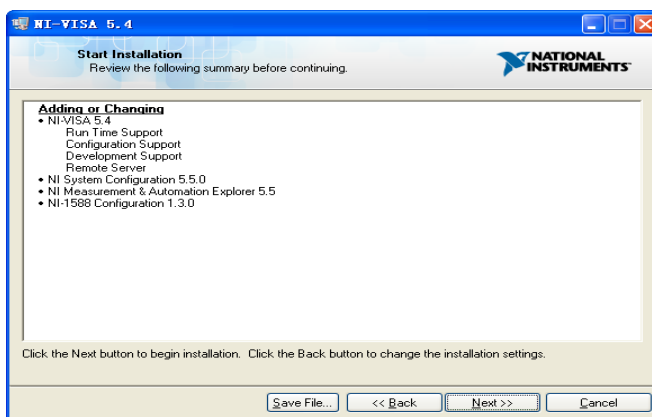

e. Click Next to run installation.

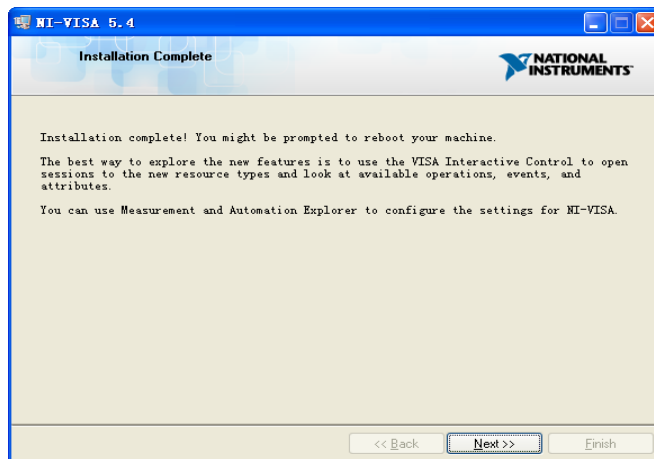

Now the installation is complete, reboot your PC.

### 3.2.2 Build Communication Using Sockets/Telnet

Through LAN interface, VXI-11, Sockets and Telnet protocols can be used to communicate with the spectrum analyzer. VXI-11 is provided in NI-VISA, while Sockets and Telnet are commonly included in PC's OS initially.

Sockets LAN is a method used to communicate with the spectrum analyzer over the LAN interface using the Transmission Control Protocol/Internet Protocol (TCP/IP). A socket is a fundamental technology used for computer networking and allows applications to communicate using standard mechanisms built into network hardware and operating systems. The method accesses a port on the spectrum analyzer from which bidirectional communication with a network computer can be established.

Before you can use sockets LAN, you must select the analyzer's sockets port number to use:

- ◆ Standard mode. Available on port 5025. Use this port for programming.
- ◆ Telnet mode. The telnet SCPI service is available on port 5024.

## 3.3 Remote Control Capabilities

### 3.3.1 User-defined Programming

Users can use SCPI commands to program and control the spectrum analyzer. For details, refer to the introductions in “**Programming Examples**”.



### 3.3.2 Send SCPI Commands via NI MAX

Users can control the spectrum analyzer remotely by sending SCPI commands via NI-MAX software.

#### 3.3.2.1 Using USB

Run NI MAX software.

- 1, Click “Device and interface” at the upper left corner of the software;
- 2, Find the “USBTMC” device symbol

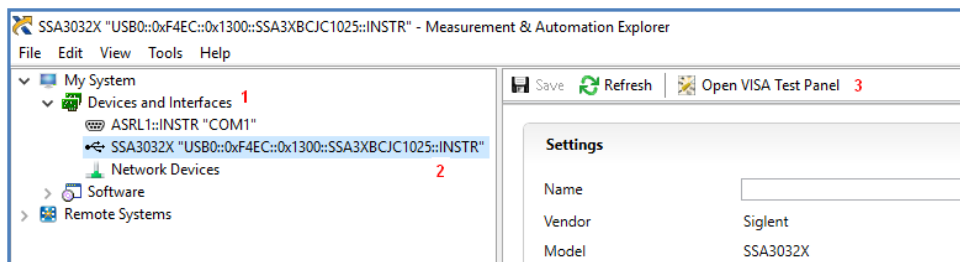

- 3, Click “Open VISA Test Panel” option button, then the following interface will appear.
- 4, Click the “Input/Output” option button and click the “Query” option button in order to view the operation information.

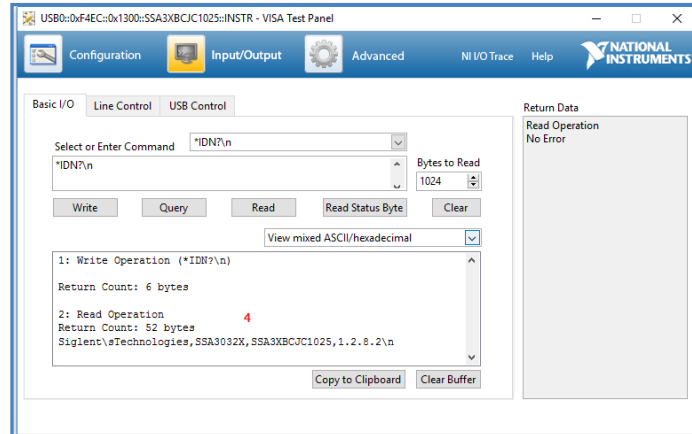

**NOTE:** The \*IDN? command (known as the Identification Query) returns the instrument manufacturer, instrument model, serial number, and other identification information.

#### 3.3.2.2 Using LAN

Select, Add Network Device, and select VISA TCP/IP Resource as shown:

Run NI MAX software.

- 1, Click “Device and interface” at the upper left corner of the software;
- 2, Find the “Network Devices” symbol; click “Add Network Devices”;

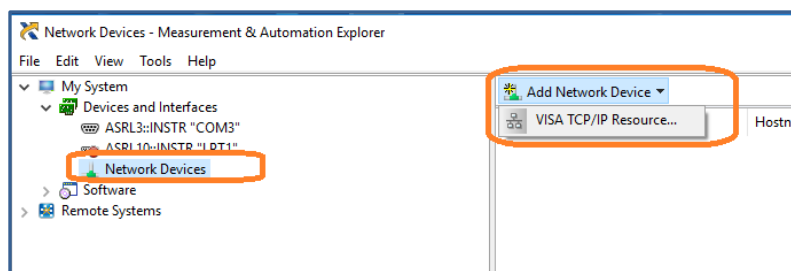

3. Select Manual Entry of LAN instrument, select Next, and enter the IP address as shown. Click Finish to establish the connection:

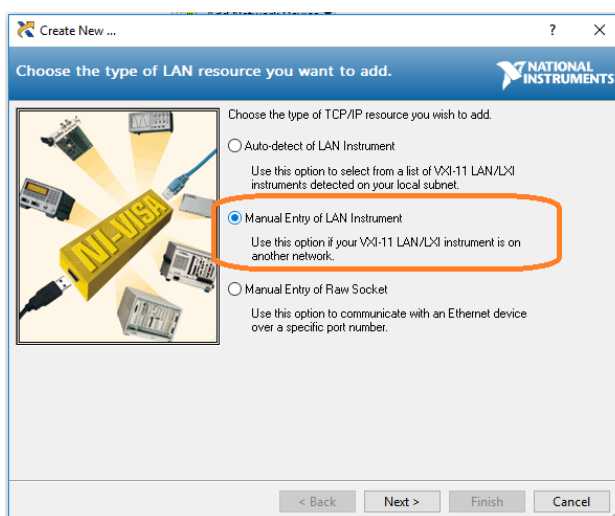

**NOTE:** Leave the LAN Device Name BLANK or the connection will fail.

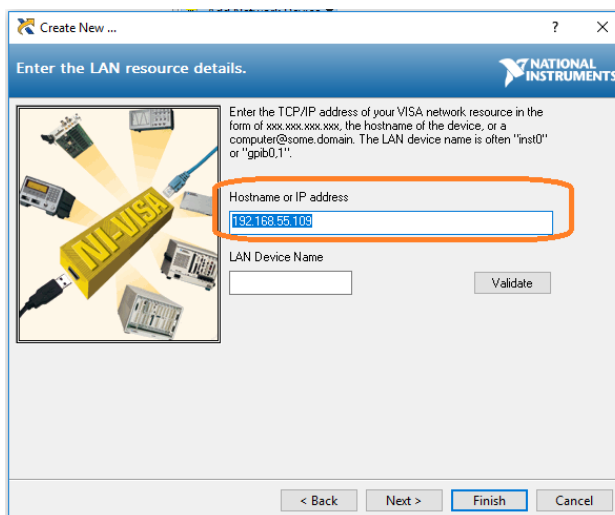

4. After a brief scan, the connection should be shown under Network Devices:

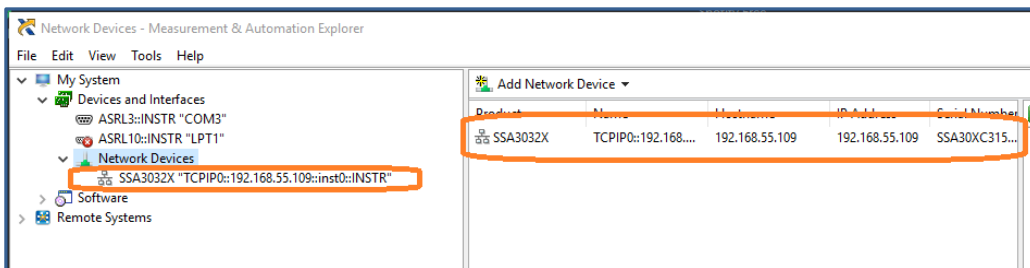

5. Right-click on the product and select Open NI-VISA Test Panel:

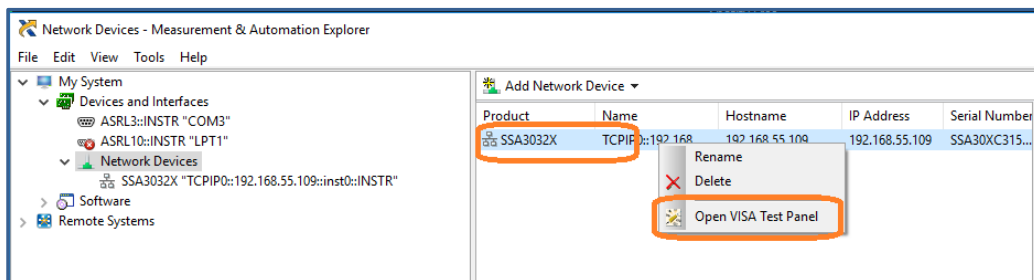

6. Click “Input/Output” option button and click “Query” option button. If everything is OK, you will see the Read operation information returned as shown below.

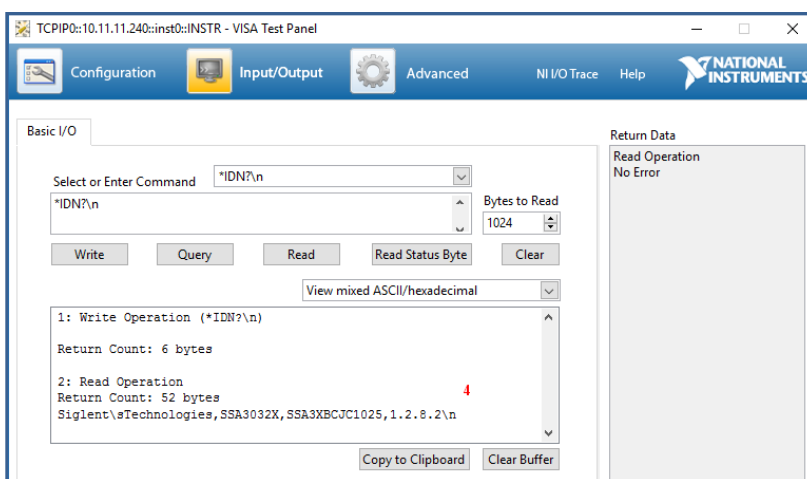

### 3.3.3 EasySpectrum Software

Users can control the spectrum analyzer remotely by EasySpectrum. PC software EasySpectrum is an easy-to-use, PC-Windows-based remote control tool for Siglent’s spectrum analyzer. You can download it from Siglent’s website. To connect the analyzer via the USB/LAN port to a PC, you need install the NI VISA first.

It is able to be used as:

- ◆ A monitor to display and control the trace scans simultaneously with the analyzer;
- ◆ A file maker to get user defined Limit/Correction files, and load them to the analyzer;

- ◆ An EMI receiver to perform EMI Pre-compliance test including pre scan, peak search, final scan and report generating.

For the further description of the software, please refer to the online help embedded in this software.

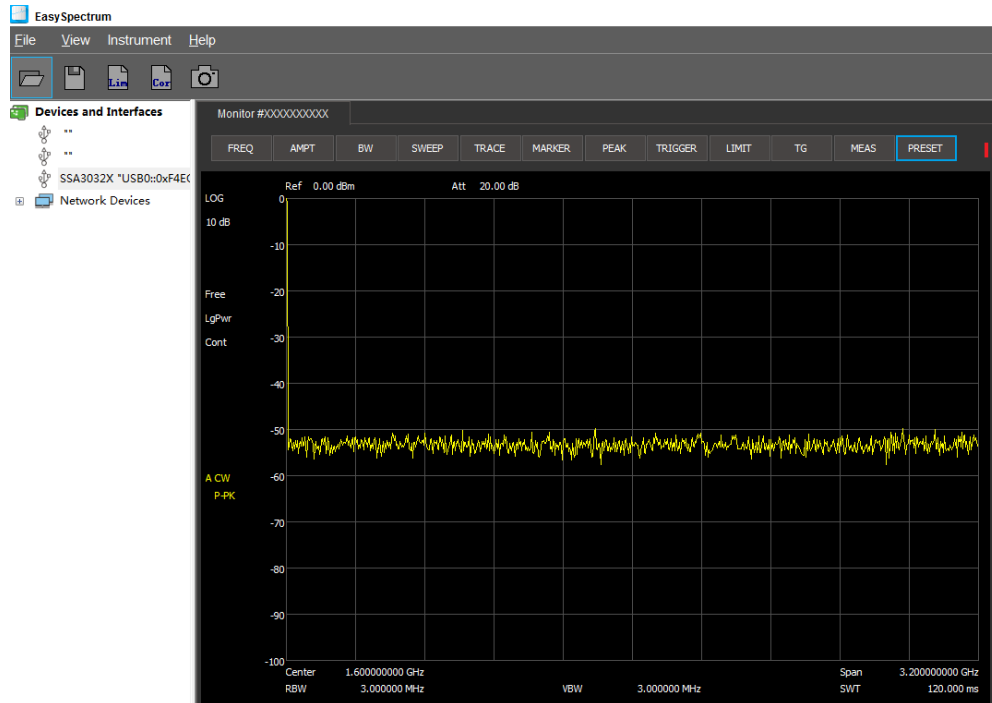

---

# Chapter 4 Troubleshooting and Service

## 4.1 Service Summary

**SIGLENT** warrants that the products that it manufactures and sells will be free from defects in materials and workmanship for a period of three years (accessories for a period of one year) from the date of shipment from an authorized Siglent distributor. If the product proves defective within the respective period, **SIGLENT** will provide repair or replacement as described in the complete warranty statement.

To arrange for service or obtain a copy of the complete warranty statement, please contact your nearest Siglent sales and service office. Except as provided in this summary or the applicable warranty statement, **SIGLENT** makes no warranty of any kind, express or implied, including without limitation the implied warranties of merchantability and fitness for a particular purpose. In no event shall **SIGLENT** be liable for indirect, special or consequential damages.

## 4.2 Troubleshooting

Before calling **SIGLENT**, or returning an analyzer for service, perform the quick checks listed below. This check may eliminate the problem.

If the problem remains still, please contact **SIGLENT** and provide your device information in the back of the analyzer.

1. **The Power Switch  is still dark after power on:**
  - (1) Check: whether the power supply is according to 1.3.2;
  - (2) Check: the power has been connected correctly;
  - (3) Check: whether the power fuse is burned. If a new fuse needs to be installed, please use a specified fuse.
  
2. **The analyzer's screen is still dark (no display) after power on:**
  - (1) Check: whether the fan is running while the screen is dark, maybe the LCD cable is loose;
  - (2) Check: whether the fan is not running while screen is dark, maybe it has failed to start up;  
Do not disassemble the instrument by yourself and contact **SIGLENT**.
  
3. **The key is unresponsive or gives a wrong response:**
  - (1) Press all the keys at the front panel to check if all of them are normal after power on.

- (2) Press **System** ->**Self Test** ->**Key Test** to check if all the keys are working properly.
  - (3) If a key is not working, the numeric keyboard connection might be loose or the numeric keyboard is broken.
- Do not disassemble the instrument by yourself and contact **SIGLENT**.

**4. The spectrum lines on the screen do not update for a long period of time:**

- (1) Check whether the screen is locked; if so, press **Esc** to unlock it.
- (2) Verify whether all the trigger conditions have been met and whether there is a valid trigger signal inputting.
- (3) Check whether the analyzer is in single sweep.
- (4) Check whether the current sweep time is too long.

**5. Wrong measurement results or poor precision:**

To calculate the system errors and check the measurement results and precision, refer to the introductions in "**Specifications**". To reach these specifications, please:

- (1) Check whether all the external devices are successfully connected and are working normally.
- (2) Get some knowledge of the signal under measurement and set appropriate instrument parameters.
- (3) Make measurements under proper conditions; for example, warm-up the instrument appropriately and operate the instrument under the specified environment temperature.
- (4) Calibrate the instrument regularly to reduce or avoid errors that might occur over time.

If you need a specific calibration after the stated calibration period, contact **SIGLENT** or get paid service from authorized measurement agencies.

**6. Pop-up Message:**

The instrument may display prompt messages, error messages or state messages according to the current working status. These messages are displayed to help you to use the instrument correctly and are not instrument failures.

## 4.3 Contact Us

### China:

#### **SIGLENT TECHNOLOGIES CO., LTD.**

Add: Bldg No.4 & No.5, Antongda Industrial Zone, 3rd Liuxian Road, Bao'an District,  
Shenzhen, 518101, China.

Tel: + 86 755 3661 5186

Fax: + 86 755 3359 1582

Email: sales@siglent.com;

[Website: http://www.siglent.com/ens/](http://www.siglent.com/ens/)

### USA:

#### **SIGLENT Technologies America, Inc**

6557 Cochran Rd Solon, Ohio 44139

Tel: 440-398-5800

Toll Free: 877-515-5551

Fax: 440-399-1211

Email: info@siglent.com

[Website: www.siglentamerica.com](http://www.siglentamerica.com)

### Europe:

#### **SIGLENT TECHNOLOGIES EUROPE GmbH**

ADD: Liebigstrasse 2-20, Gebaeude 14, 22113 Hamburg Germany

Tel: +49(0)-819-95946

Fax: +49(0)-819-95947

Email: info-eu@siglent.com

[Website: www.siglenteu.com](http://www.siglenteu.com)